

# ISLAMIC STUDIES

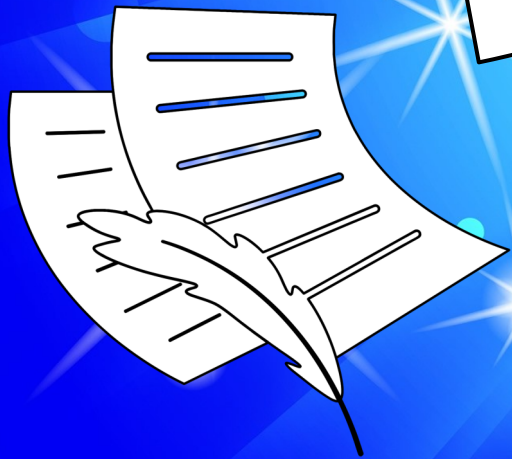

# JUST THE BASICS



## Topics Covered

Allah \* Angels of Allah \* Books  
of Allah \* Prophets of Allah





With Start Bismillah

My Name is:

**1. Allah**

**p1**

**2. Angels  
OF Allah**

**p21**

**7. Life  
after  
Death**

**Iman-e  
MuFassal**

**3. Books  
of Allah**

**p42**

**6. Qadr**  
all good and bad  
is from Allah

**4. Prophets  
of Allah**

**p71**

**5. The  
Last Day**

Find in  
Book Two



رَبِّ زِدْنِي عِلْمًا

“My Lord! Increase me in knowledge.”

Holy Qur'an 20:114



# Allah

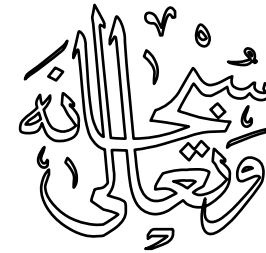

ALLAH

Allah is **One**

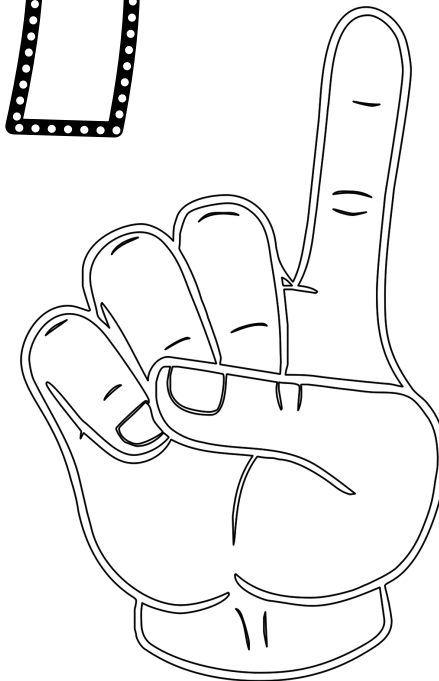

 Subhanahu wa ta'ala"  
The Most Glorified,  
the Most High.

# Allah has...

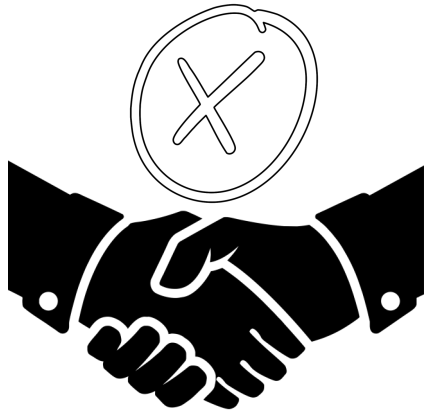

No Partners

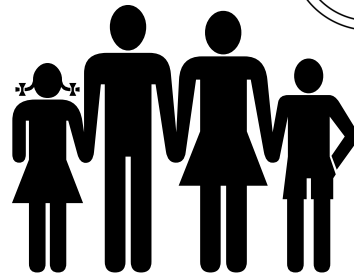
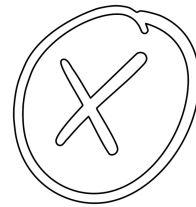

No Family

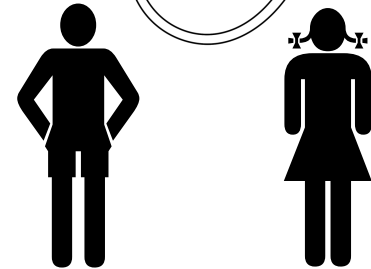
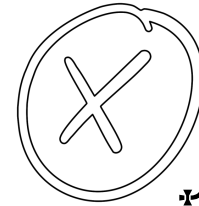

No Kids

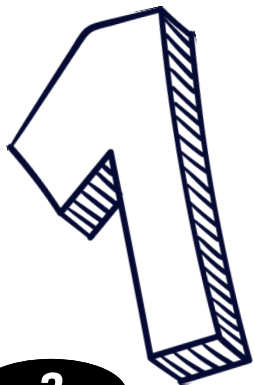

**Allah is Absolutely ONE**

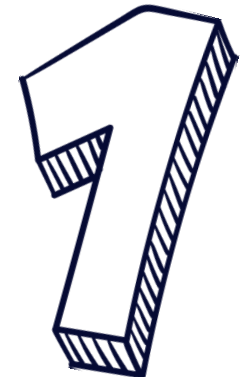

We **don't know** what

Allah looks like

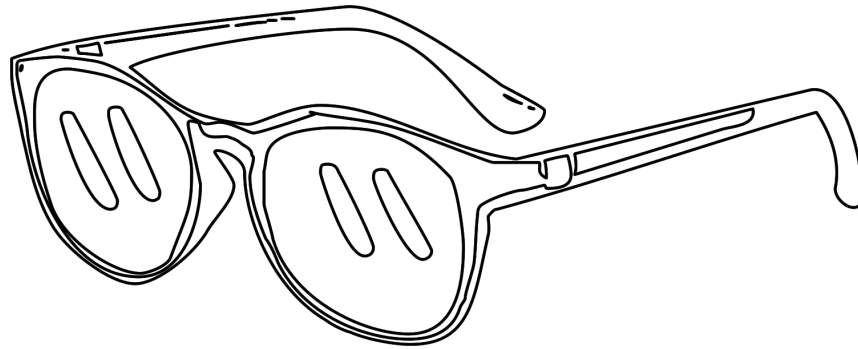
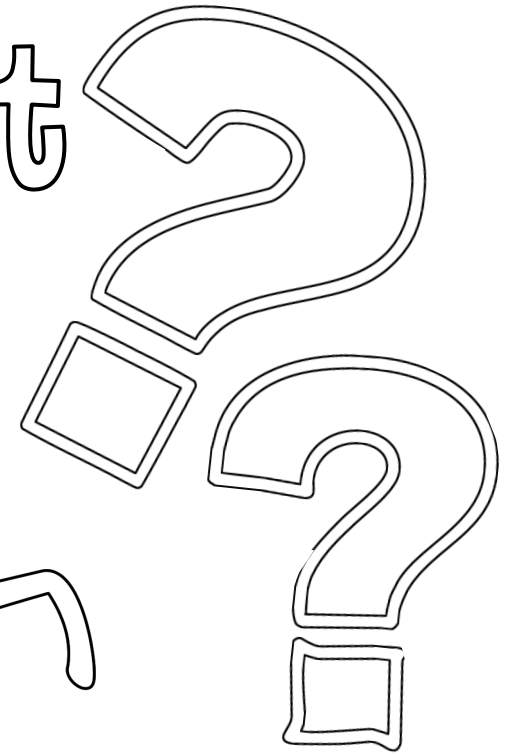

ALLAH



Allah is **not** like  
anything we can  
**see or imagine.**

Allah is not  
similar to  
anything in  
creation.

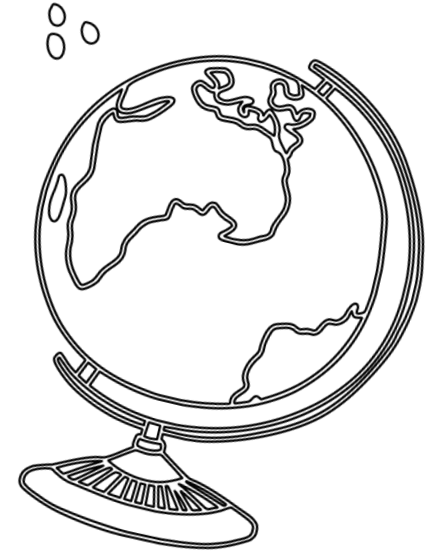

Allah **doesn't**

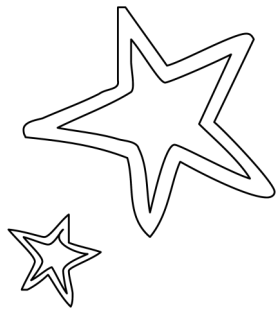

look like a



human being!



We know Allah  
through His

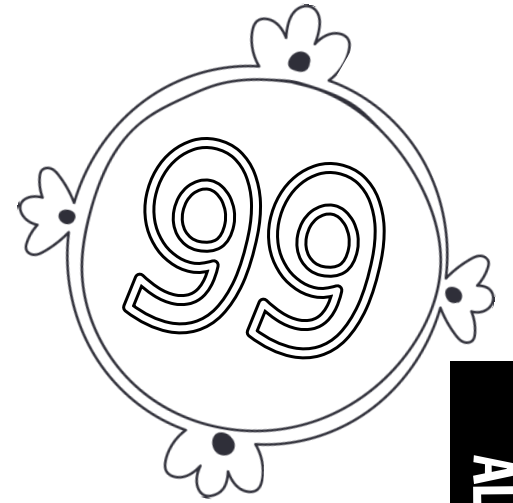

ALLAH

According to  
Hadith, there are  
99 names of  
Allah. We should  
learn them and  
understand  
them. They will  
take us closer to  
Allah ﷻ.

Names

( Attributes or Qualities )

Asma ul Husna

# We worship

Worship means to obey Allah ﷻ

only

Allah

Allah ﷻ  
created Humans  
and Jinn to  
obey Him.

It means  
choosing to live  
within the  
commandments  
of Allah.



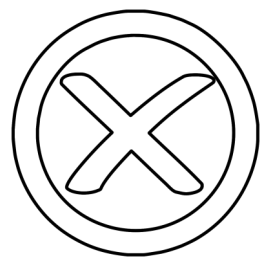

# Allah made

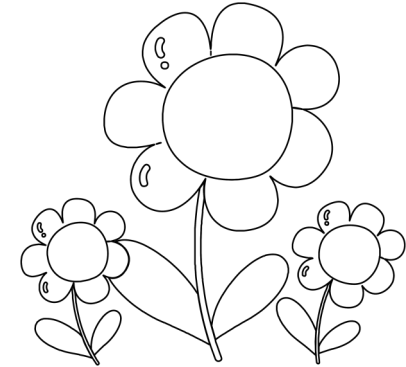
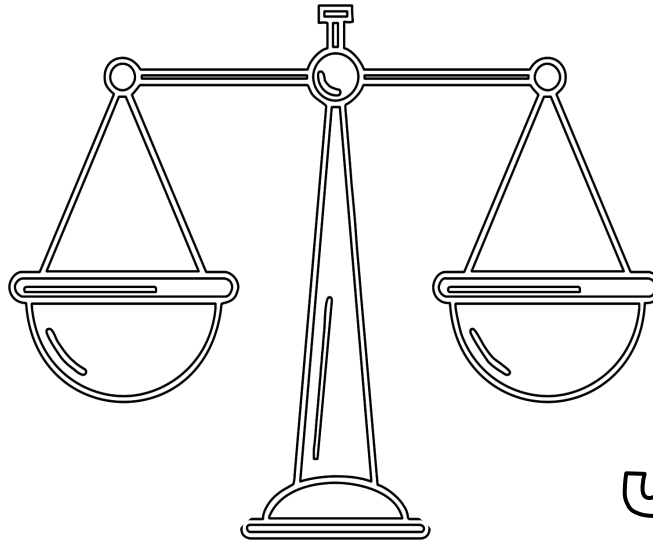
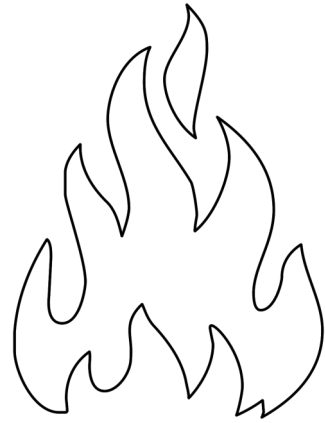

ALLAH

Jahannam as  
a **punishment**  
for bad people

Jannah as a  
**reward** for  
good people

**Allah is the Malik of the Day of Judgement.  
He will judge how we lived our lives on Earth.  
Allah will reward good people with jannah.**

Shirk is when we  
associate **partners** with Allah.

**1** Remember  
Shirk is the  
biggest Sin!

**2** Allah ﷻ will not  
forgive shirk!

**3** We must be  
careful  
about shirk!

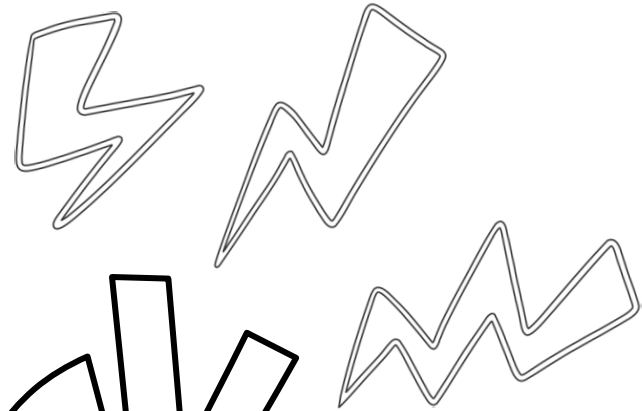
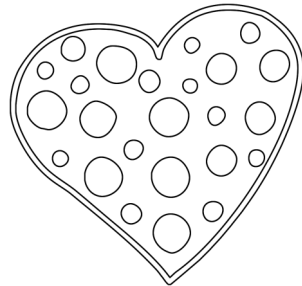

Shirk

If we give something  
else an attribute of  
Allah it is also shirk, e.g.  
if we think something  
else is All-Powerful.

**Worshipping Allah includes having good manners and character. Dealing with people in a good, honest, kind and just way.**

# Amazed

Allah created Humans and Jinn to worship Him. This means that we need to live according to Allah's commands.

Help Abdullah get to the soup kitchen to help serve food to poor people.

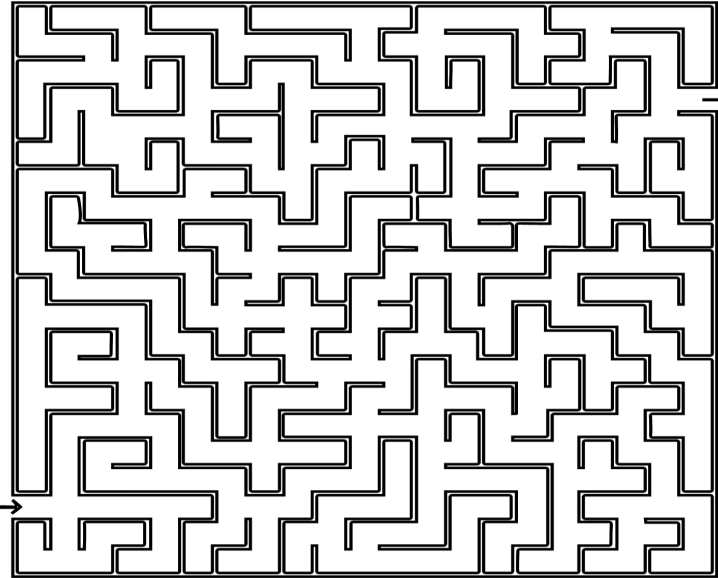

If we can help people, we should help as much as possible. There is a lot of poverty and hardship in the world. Helping is also part of worship.

ALLAH

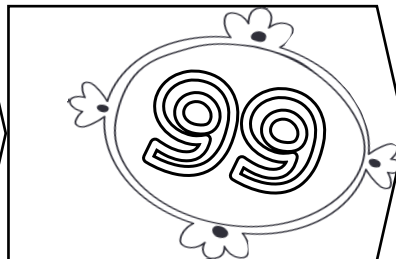
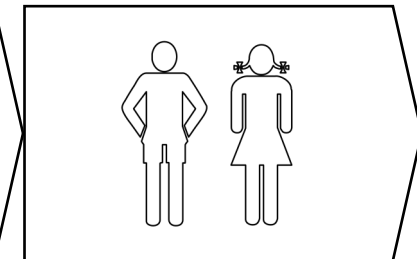
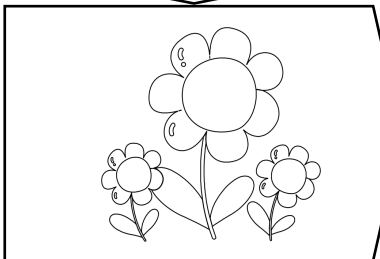
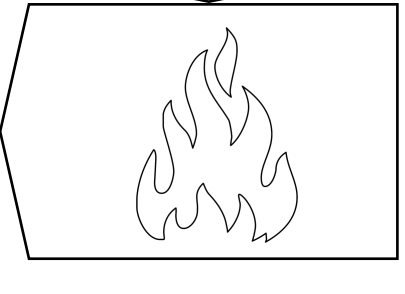
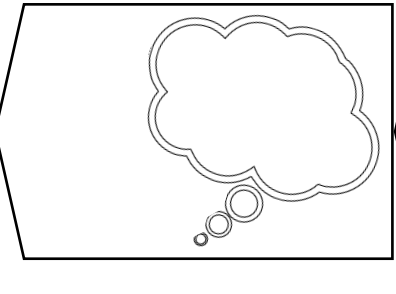
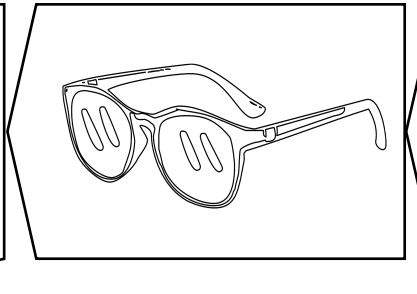
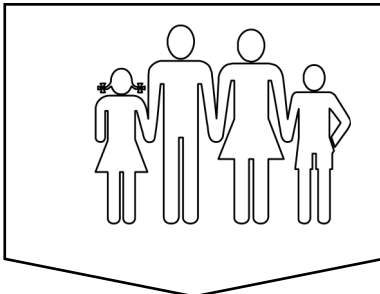
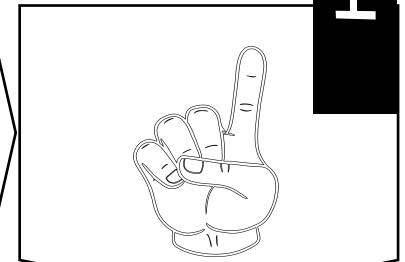
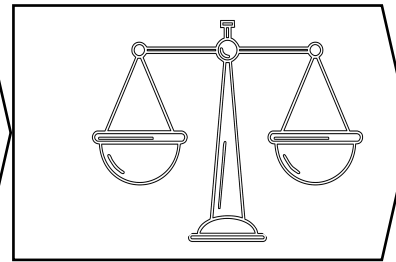
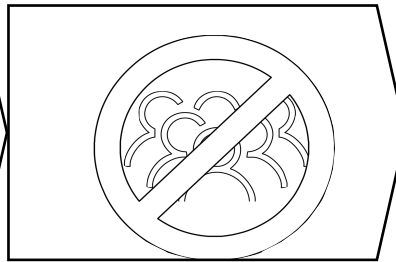
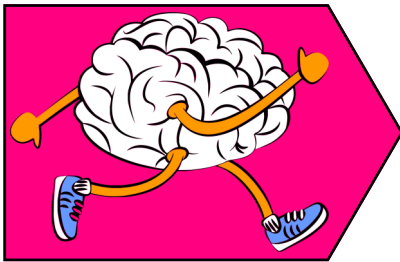

We can't see Allah

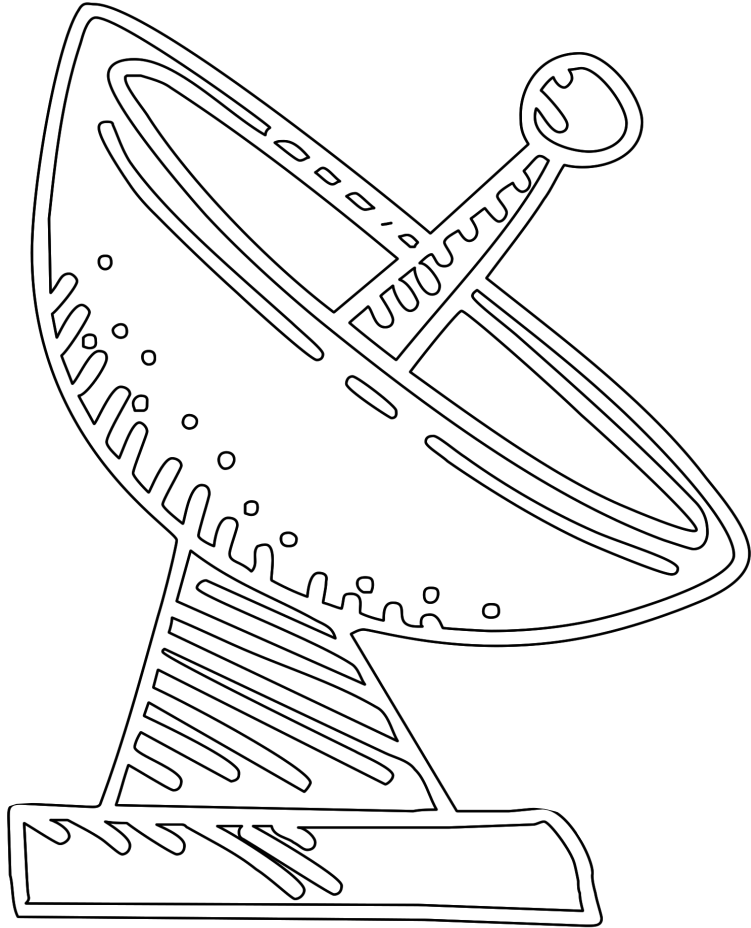

**Al-Baseer** 

The All-Seeing



but Allah can see us!



Allah ﷻ was there before everything else and will always be there forever



ALLAH

Allah doesn't have a beginning nor end

**Al-Awwal** 

The First - 'Beginning-less'

**Al-Aakhir** 

The Last - 'Endless'

# Allah Created Everything

Al-Khaliq



The Creator

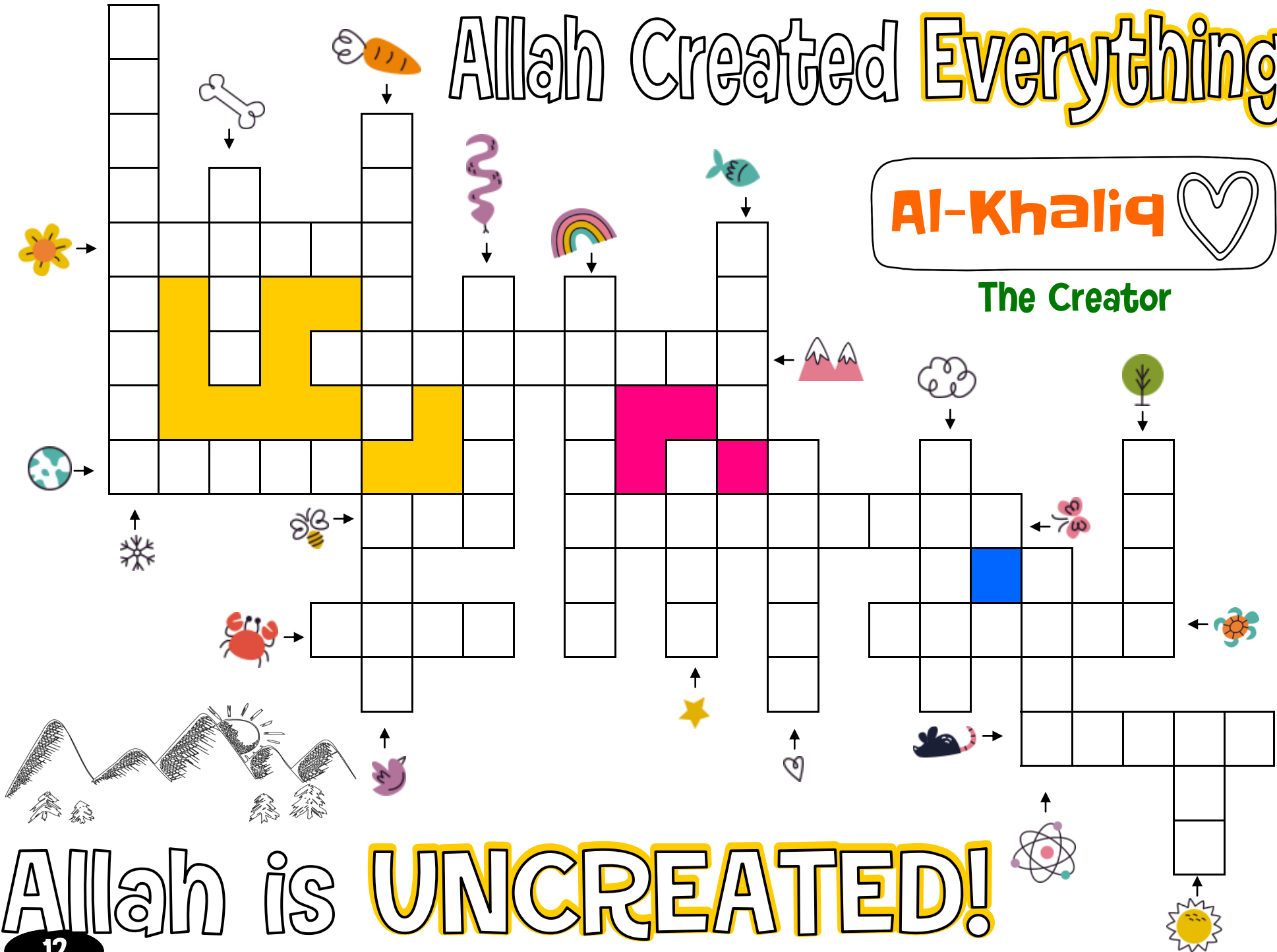

Allah is UNCREATED!



# Allah provides for every living thing

ALLAH

**1** Allah ﷻ does not need to eat, drink or sleep.

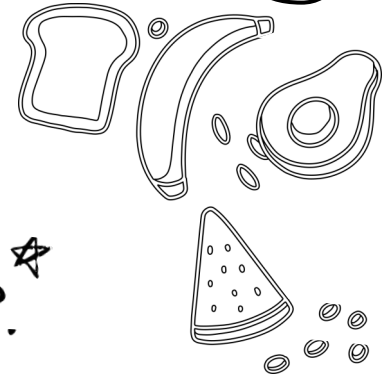

**2** Allah ﷻ sustains all creation but doesn't need any sustenance.

**Ar-Razzaq**



← The Provider

# Allah is the All-Powerful

If the entire creation was to gather to harm someone, they couldn't harm that person unless Allah allowed it.

**Al-Qadeer**



**The All-Powerful**

Allah has the power to help us when we are in need.

NOTHING CAN HAPPEN  
UNLESS ALLAH ALLOWS IT

# Allah is All-Forgiving

If we sincerely turn to Allah,  
Allah will forgive us.

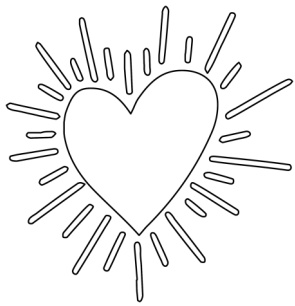

Allah ﷻ  
is All  
FORGIVING  
and All  
MERCIFUL

Allah loves to forgive us  
and have mercy on us. We  
should call on Allah alone for  
even the smallest thing.

**Al-Ghaffar** 

The All-Forgiving

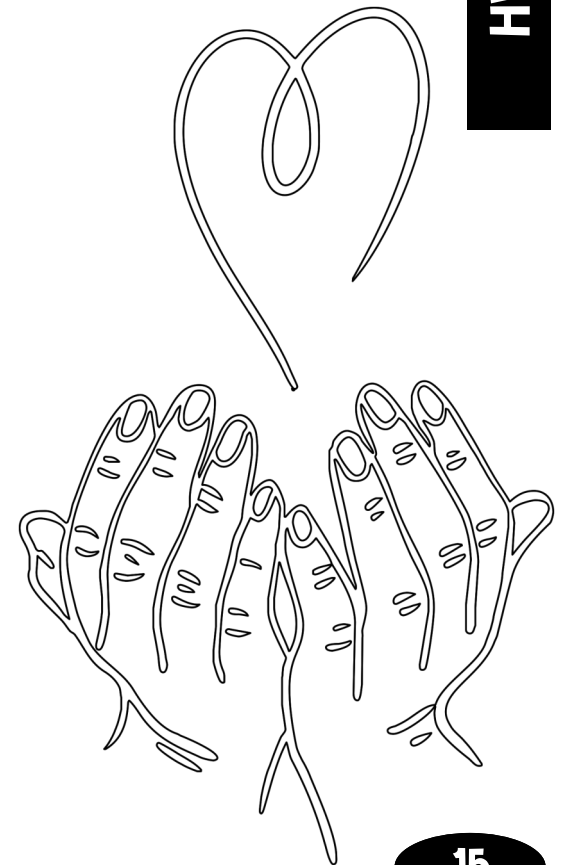

ALLAH

# Allah Knows Everything



**Al-'Aleem**



**The All-Knowing**

**Shhh.**

**Allah ﷻ knows  
the Past, Present  
and Future**

**Allah ﷻ even  
knows our most  
hidden secrets!**

**Not even a leaf  
drops without  
Allah ﷻ knowing  
it!**

**Allah ﷻ knows  
everything we  
say, do and think**

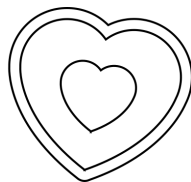

Everything needs Allah but  
 Allah doesn't need **anything**

ALLAH

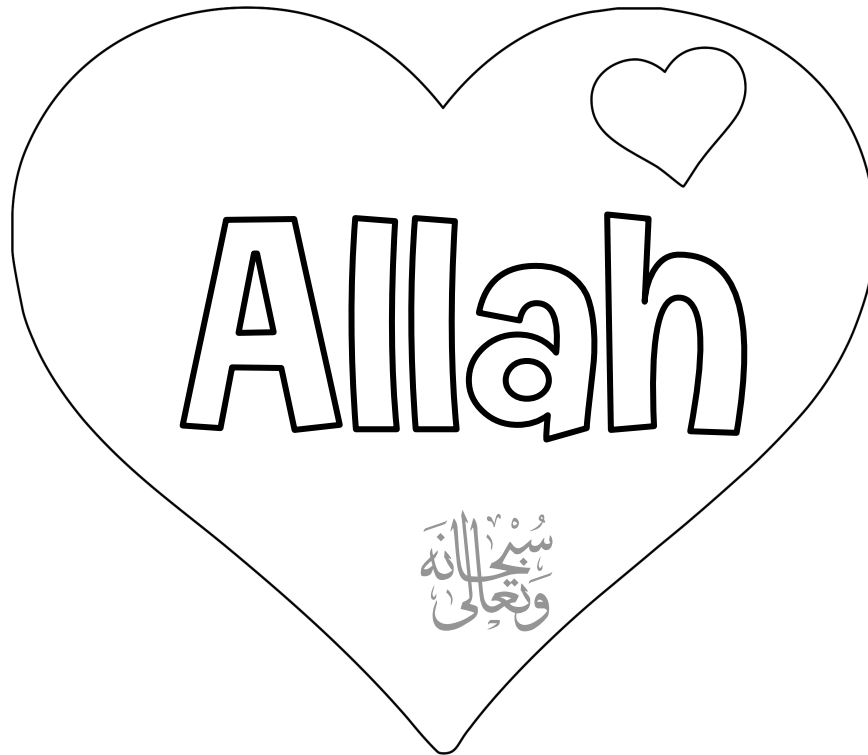
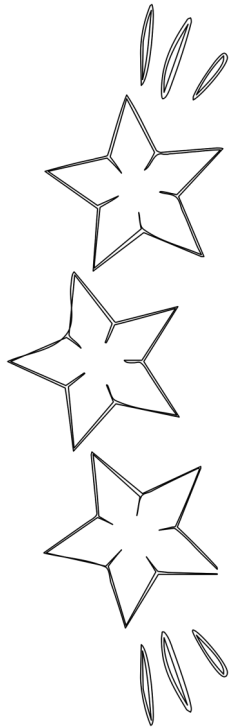

 SEARCH

|   |   |   |   |   |   |   |   |
|---|---|---|---|---|---|---|---|
| B | B | A | S | E | E | R | K |
| B | R | R | M | E | E | L | A |
| R | C | A | M | H | Q | J | G |
| C | R | Z | A | I | A | H | H |
| R | D | Z | L | M | D | J | A |
| I | G | A | I | M | E | L | F |
| H | H | Q | K | L | E | A | F |
| K | D | P | G | N | R | W | A |
| A | F | Q | N | L | K | W | R |
| A | F | P | D | A | M | A | S |

**NAMES OF ALLAH**

The Independent >>

**AS-Samad** 

<< The Self-Sufficient

# CROSSWORD

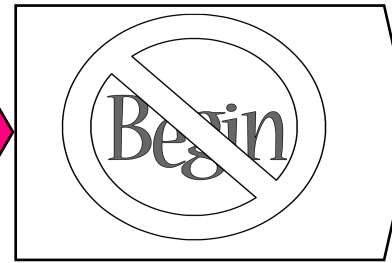
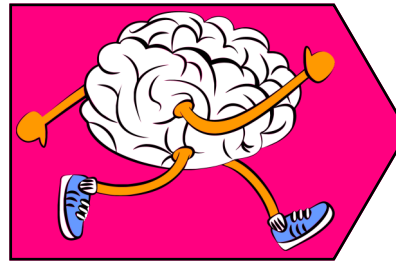
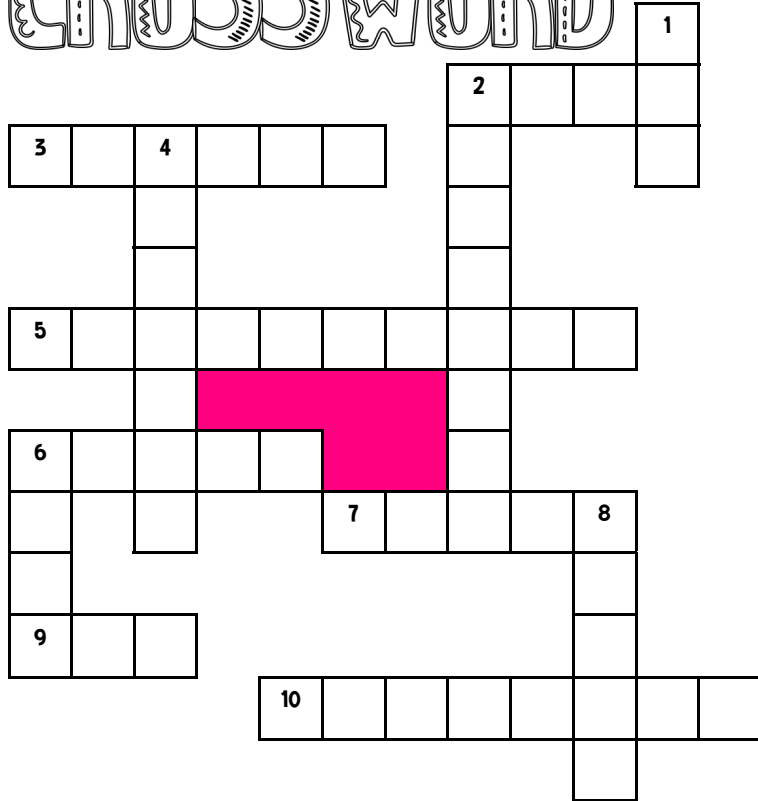

**Al-Malik**

**Self-Sustaining  
Independent**

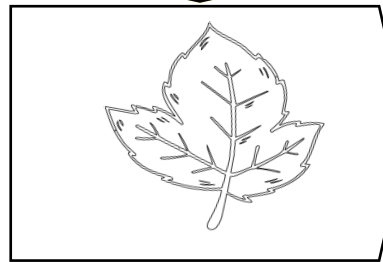
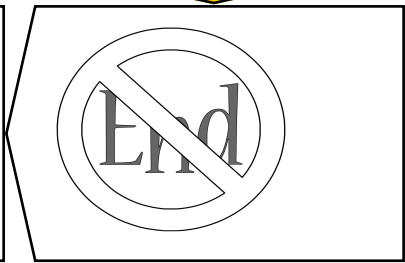
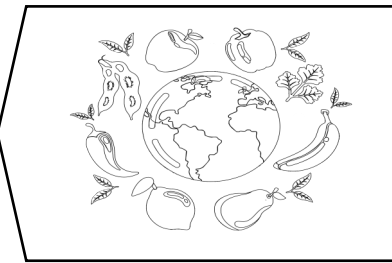

**Al-Qadeer**

**Al-'Aleem**

**Al-Khaliq**

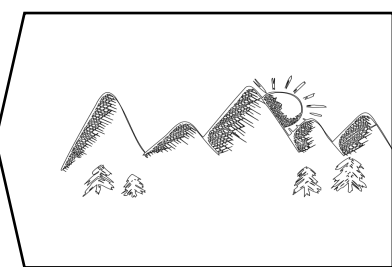

**Al-Awwal**

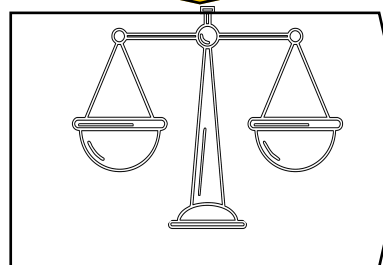

**As-Samad**

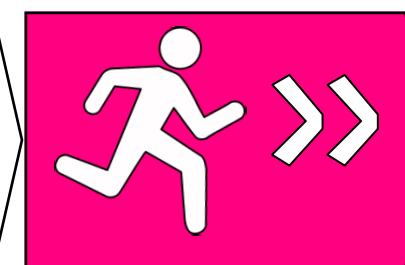

1. Tawheed means that Allah is \_\_\_\_\_.
2. Allah punishes people with \_\_\_\_\_ in the next life.
4. To obey Allah's command means to \_\_\_\_\_ Him.
6. With sincere repentance, Allah forgives \_\_\_\_\_.
8. Allah has 99 \_\_\_\_\_ or attributes.

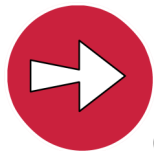

2. Humans and \_\_\_\_\_ have free will.
3. Jannah is a r\_\_\_\_\_ for good people.
5. Allah provides su\_\_\_\_\_ for all creation.
6. \_\_\_\_\_ is to worship something apart from Allah.
7. Allah is not like a \_\_\_\_\_ being.
9. Saying Allah has a \_\_\_\_\_ is Shirk.
10. Allah does not have any p\_\_\_\_\_.

# Summary

1

## Al-Baseer

Allah is All-Seeing. Allah sees everything.

2

## Al-Khaliq

Allah is the Creator of everything.

3

## Al-Razzaq

Allah is the Provider and Sustainer.

4

## As-Samad

Allah does not rely on or need anything.

5

## Al-Ghaffar

Allah is the Forgiver of all sins.

6

## Al-'Aleem

Allah is All-Knowing. Allah knows everything.

7

## Al-Malik

Allah is the Lord of all creation.

8

## Al-Qadeer

Allah is the All-Powerful.

9

## Al-Awwal & Al-Aakhir

Allah is the First & the Last.



ALLAH

# WORD FIT

If you know the meaning of each name, fit them into the grid.

Al-Baseer  
Al-Razzaq  
Al-Ghaffar  
As-Samad

Al-'Aleem  
Al-Qadeer  
Al-Malik  
Al-Awwal  
Al-Aakhir

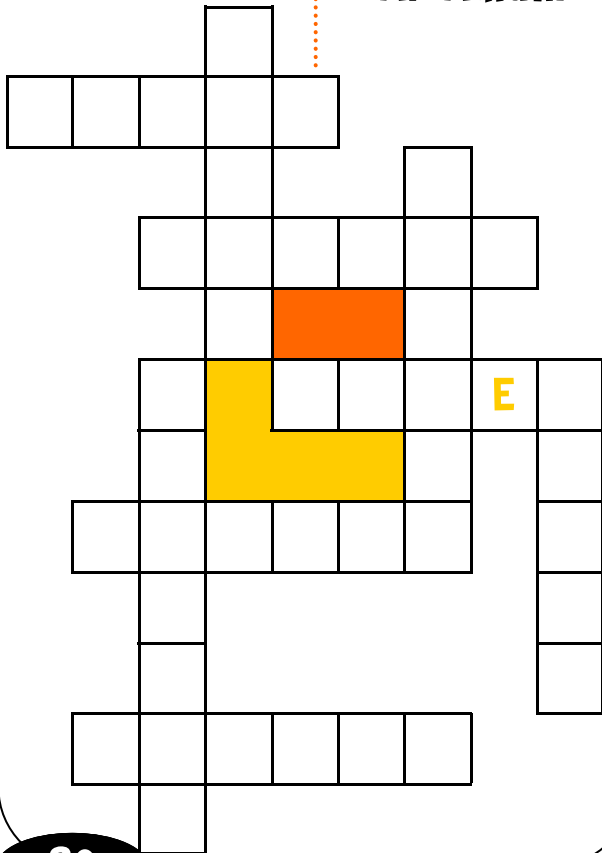

## Amazed



Aminah is studying the Qur'an with her teacher. Help her get to Madrasah before her class starts.

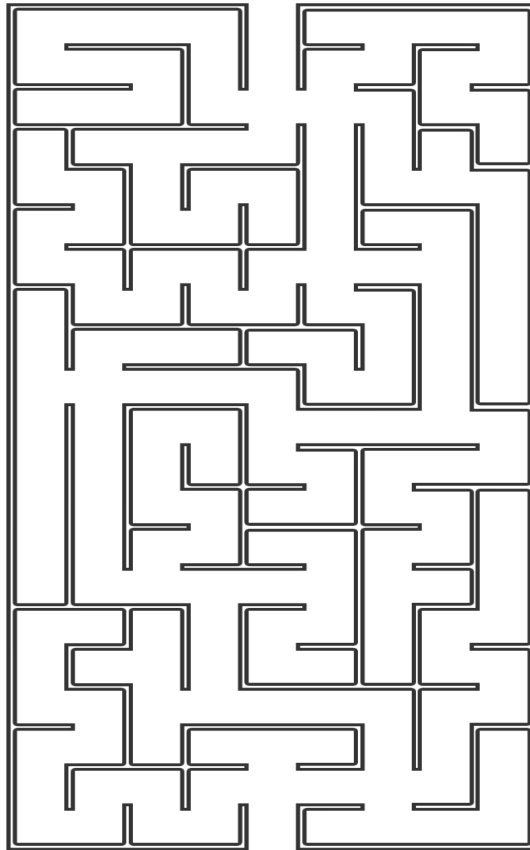

Learning the Qur'an, knowing its meaning, and applying it in our lives is essential.

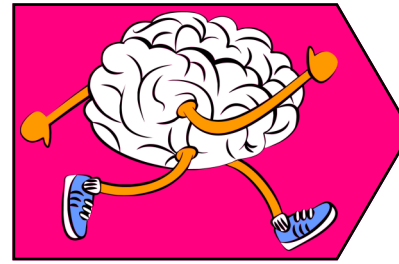

Al-Ghaffar



Ar-Razzaq

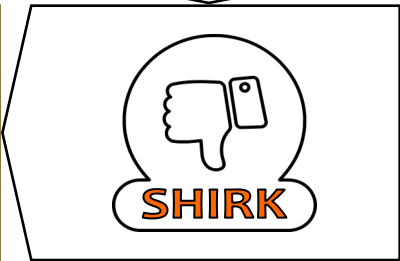

SHIRK

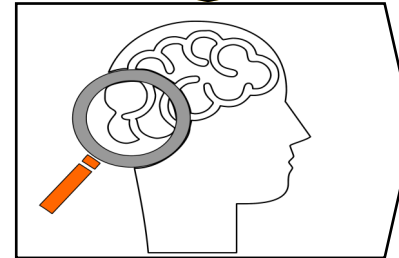

Al-Aakhir

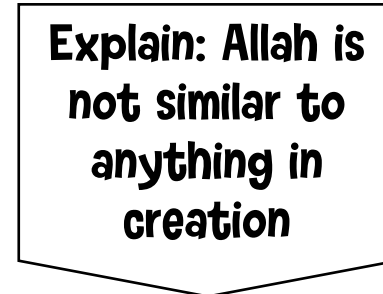

Explain: Allah is not similar to anything in creation



All-Seeing

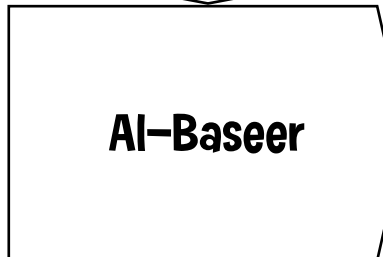

Al-Baseer

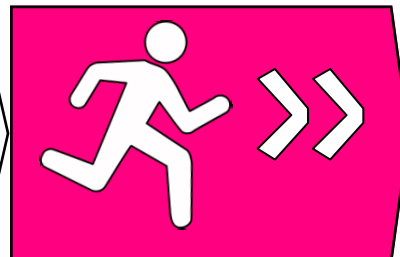



ملائكة

Angels

Angels are called Malaika in Arabic

# Angels

are made of



# NOOR

- Special light -

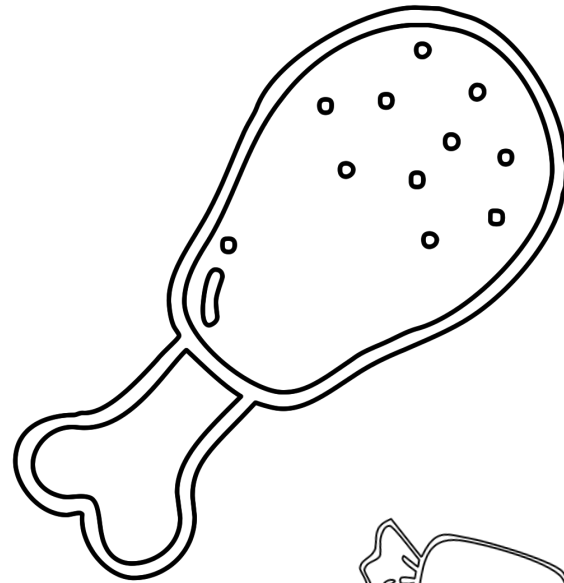
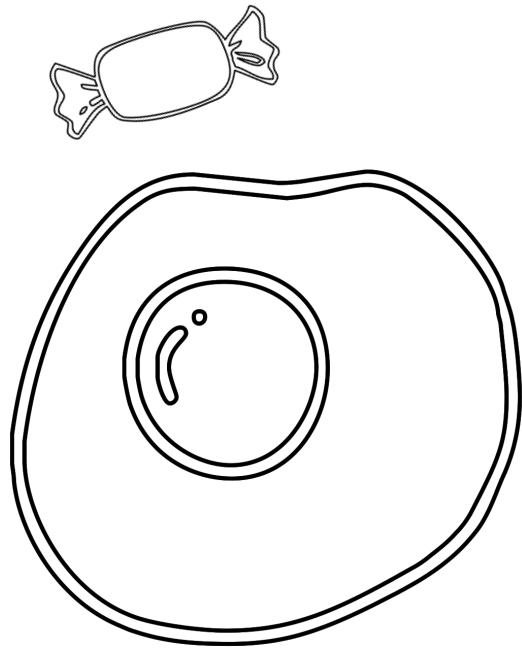

ANGELS

Angels don't need food or drink

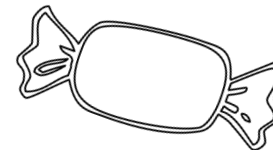
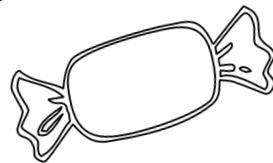
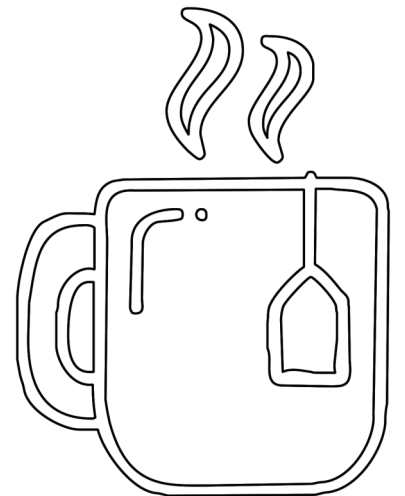
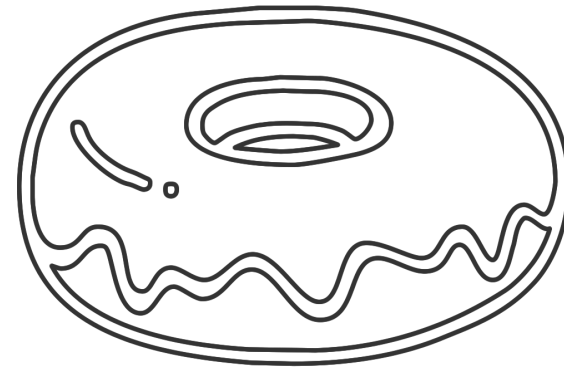
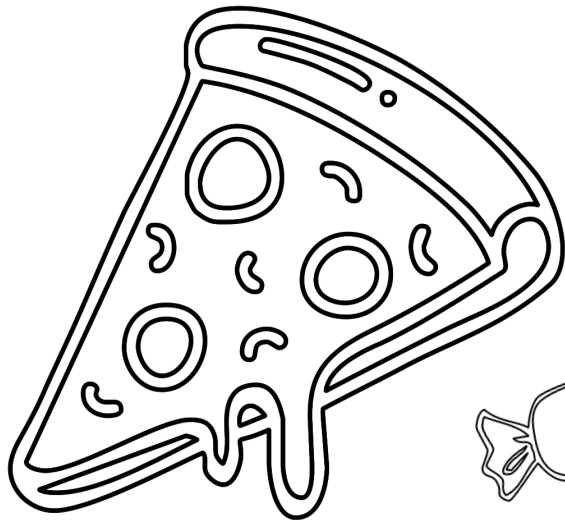
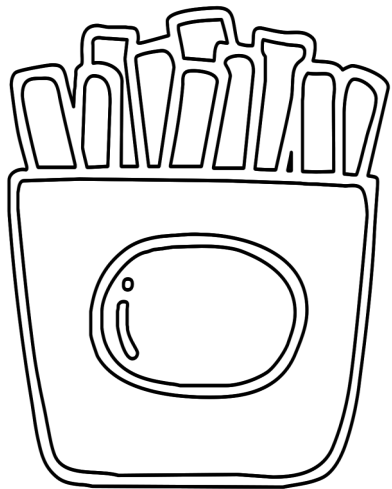

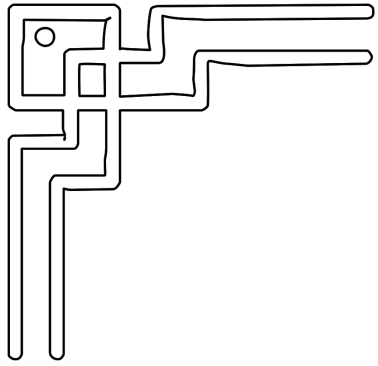

# Angels

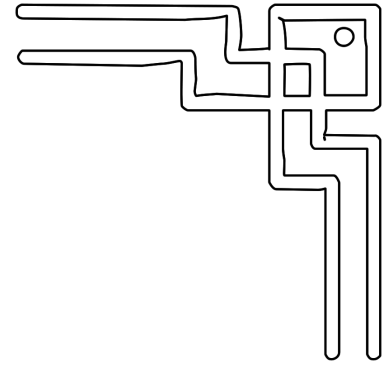

Remember humans get old. Our Prophet Muhammad ﷺ said

He is not one of us who is not merciful to our youngsters and does not respect and honour our elders."

This hadith is from Tirmidhi

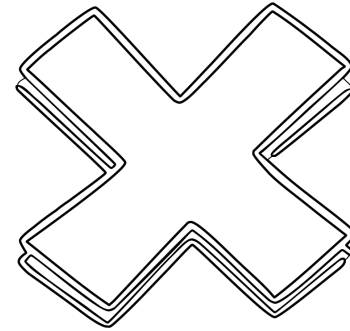
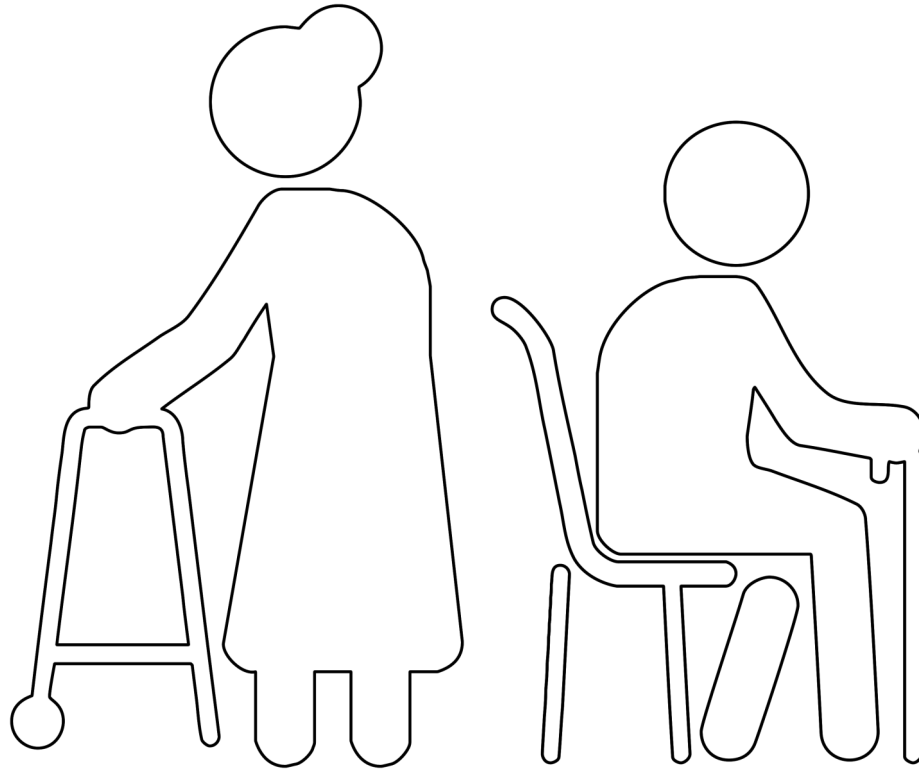

# never get old

Angels always obey Allah's command.

Angels can't choose what to do, they don't have a choice.

# Angels

don't have free will

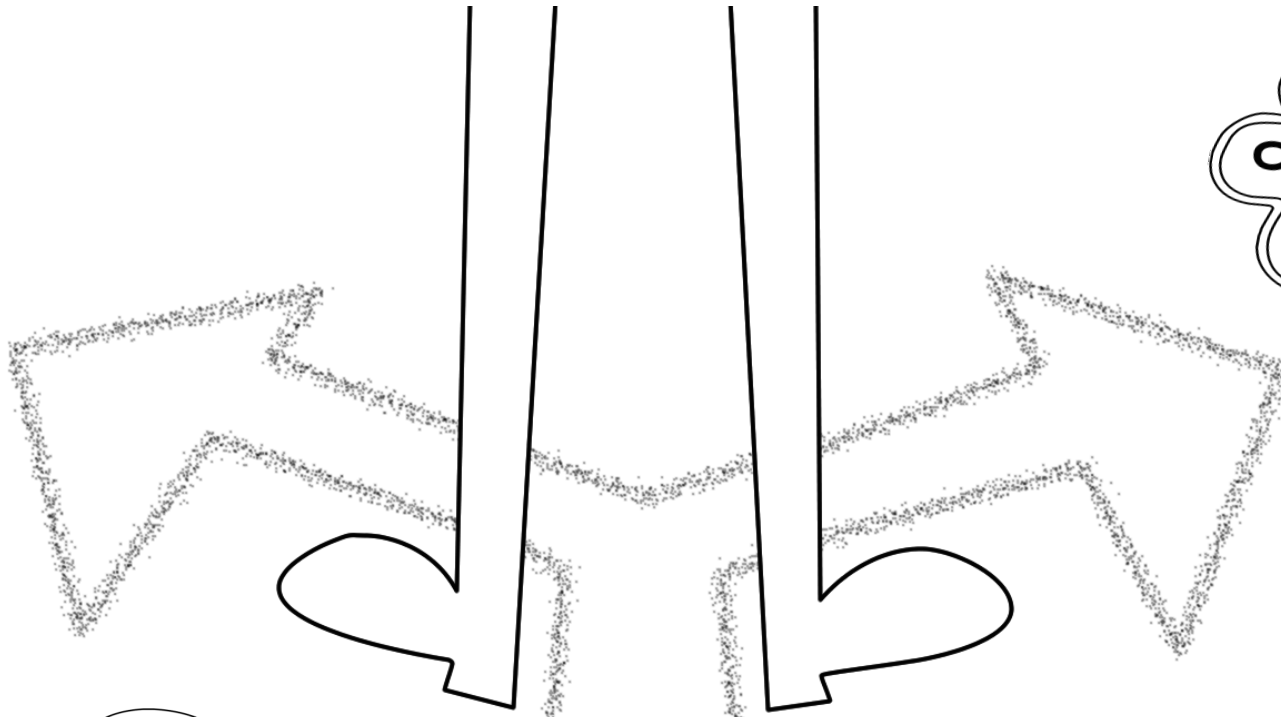

# We can't see Angels



Sometimes  
Angel Jibrael  
ﷺ would  
come with the  
revelation of  
the Qur'an in  
the form of a  
man.

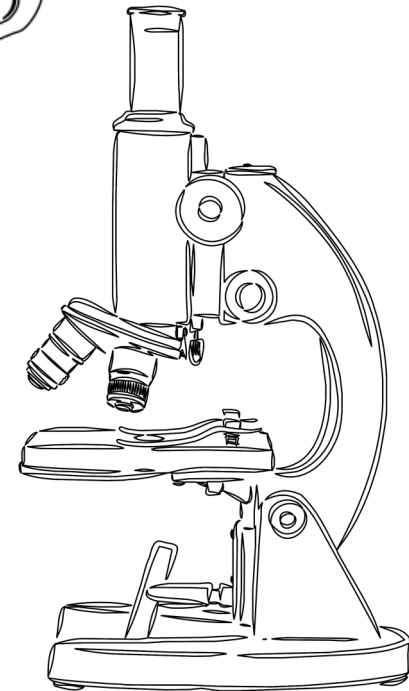
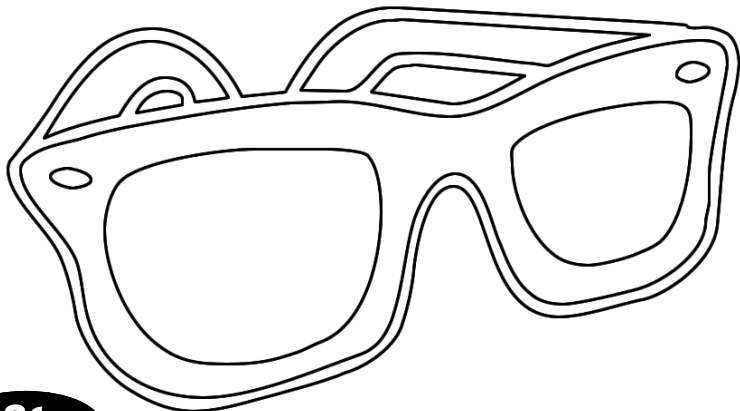
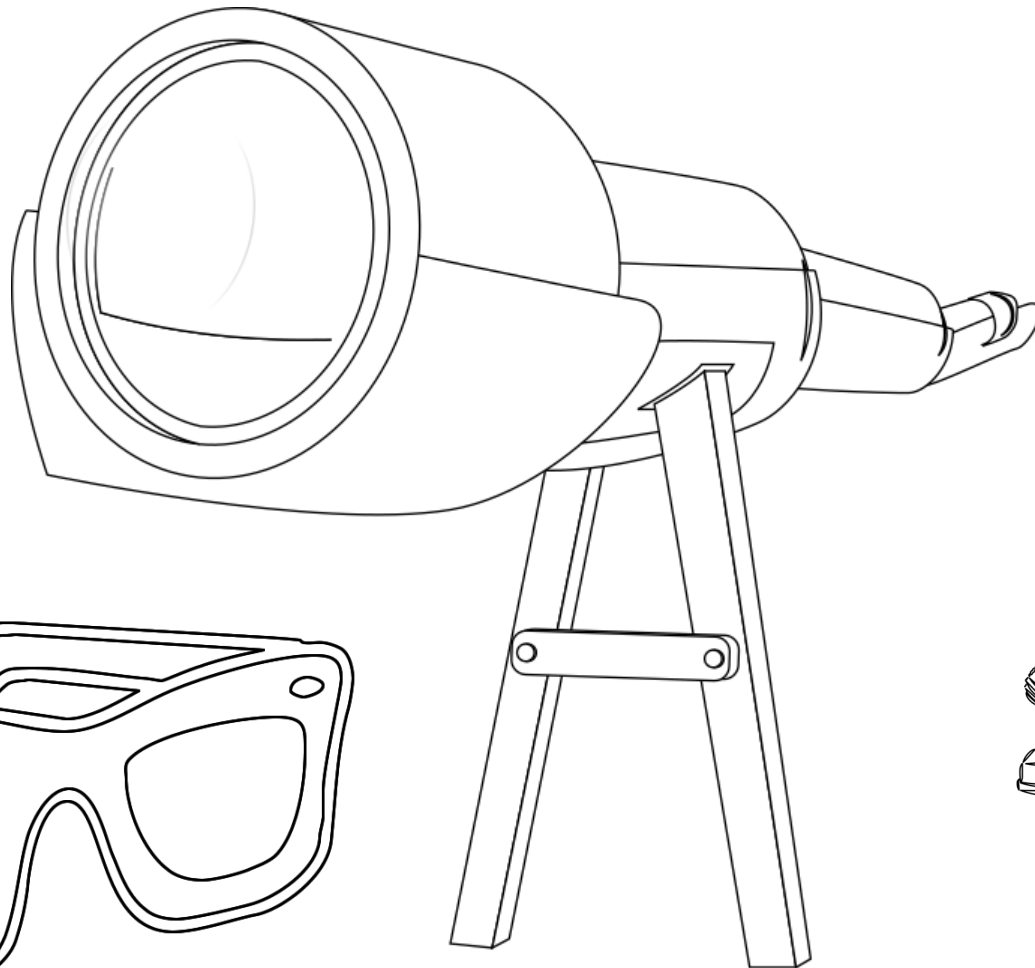

Allah made a countless  
number of Angels

REMEMBER

Angels come in different  
shapes and sizes!

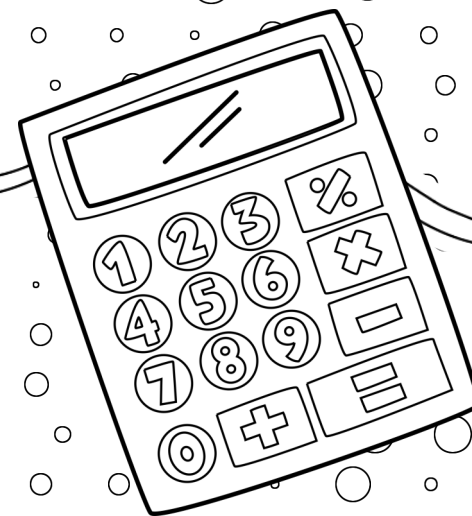

# Angels

DON'T HAVE A GENDER

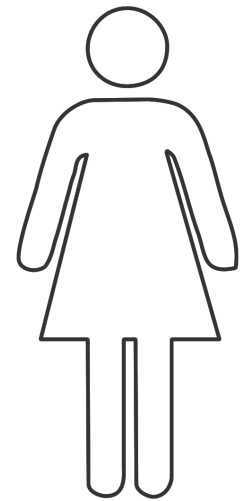
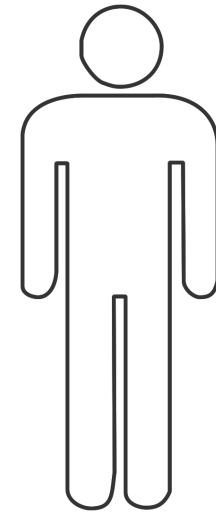
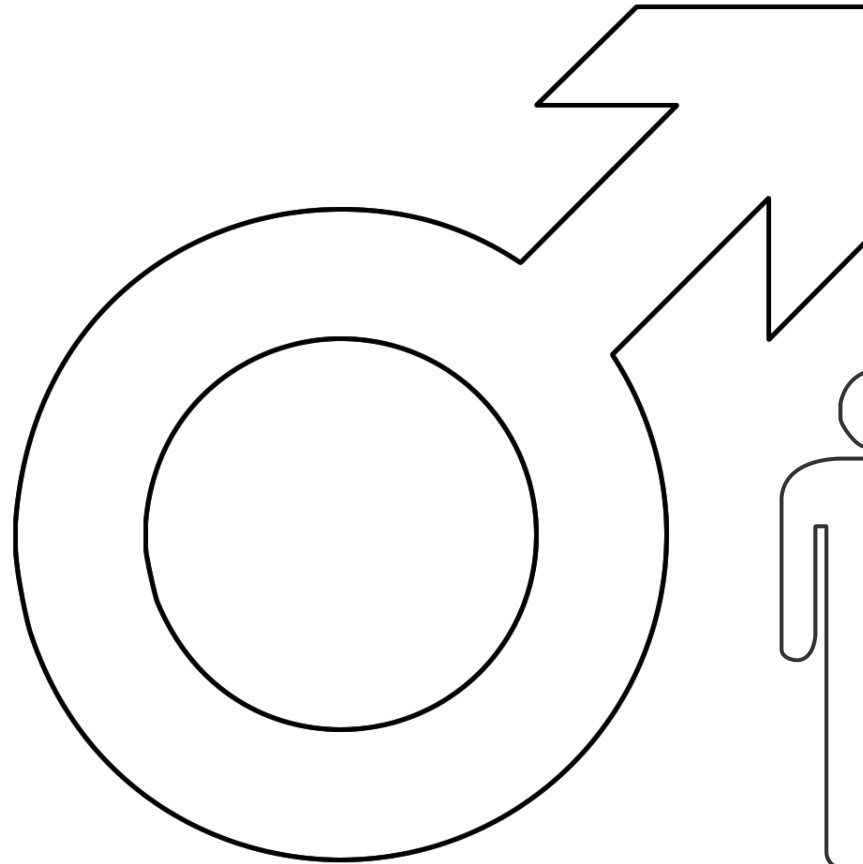
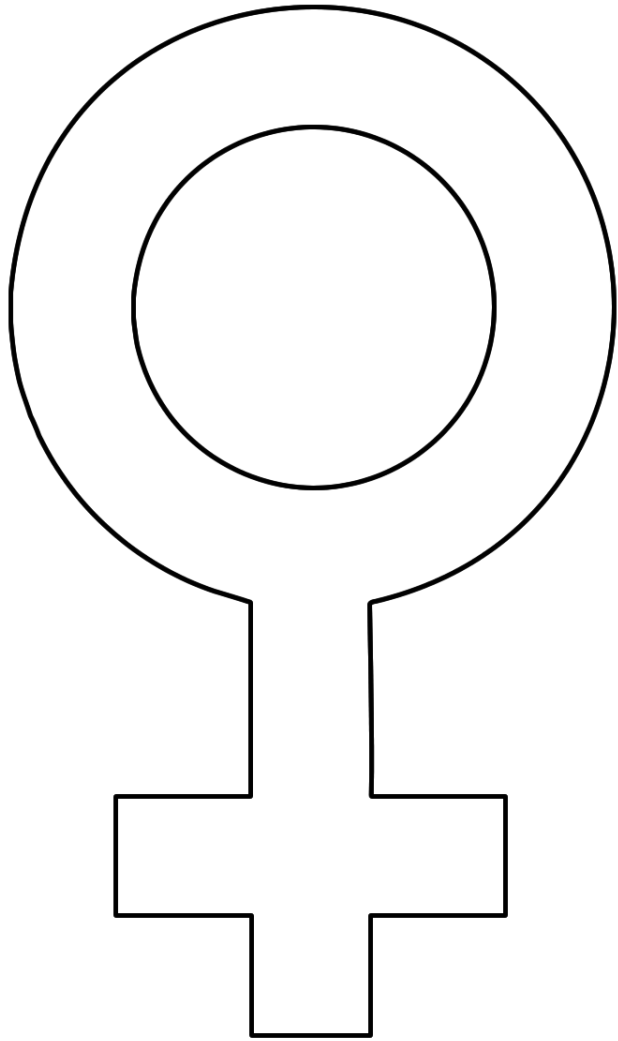

Angels are not  
male or female.



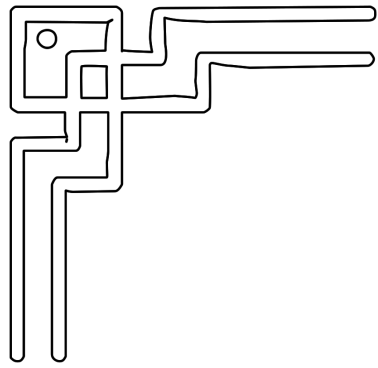

# Angels

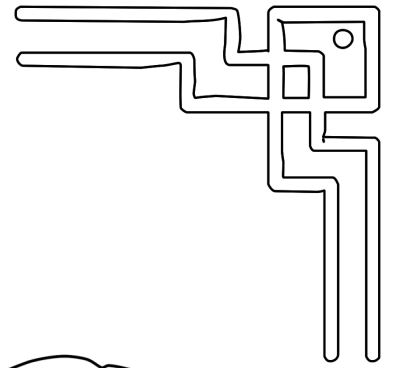

ANGELS

 SEARCH

COUNTLESS  
DRINK  
FAMILIES  
FOOD  
FREEWILL  
GENDER  
LIGHT  
NOOR  
OLD  
SEE

|   |   |   |   |   |   |   |   |
|---|---|---|---|---|---|---|---|
| B | B | R | E | D | N | E | G |
| E | E | S | G | N | N | S | P |
| L | C | F | G | M | F | S | W |
| L | F | C | D | D | A | E | P |
| I | N | O | O | R | M | L | V |
| W | D | O | L | D | I | T | Q |
| E | F | D | I | L | L | N | R |
| E | C | K | G | M | I | U | K |
| R | J | H | H | K | E | O | R |
| F | H | J | T | L | S | C | Q |

ANGEL KEYWORDS

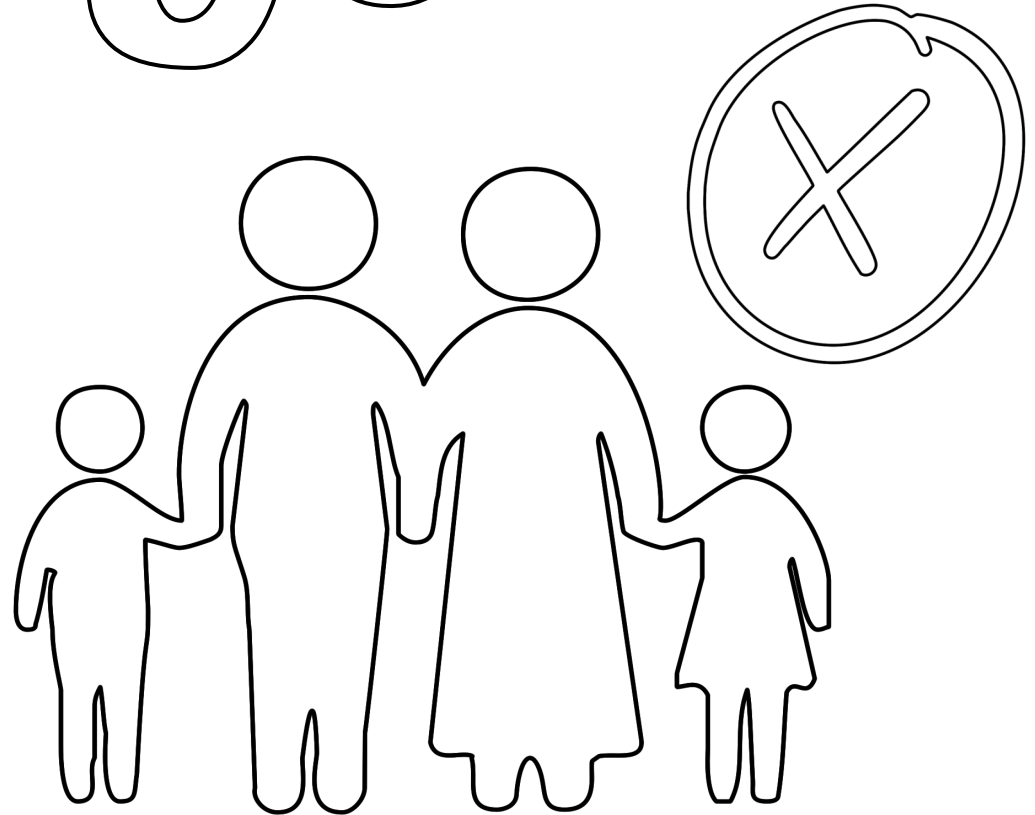

don't have families



Some people say that Shaytan is a fallen angel. An angel that disobeyed Allah. What does Islam say?

Angels don't have free-will so they can never disobey Allah. Shaytan was a jinn. Only jinn and humans have free-will.



Help me find the bin to throw out all my posters, pictures and other junk!



# Amazed

Angels of Rahma (mercy) do not come to a house where there are pictures or statues of living things!

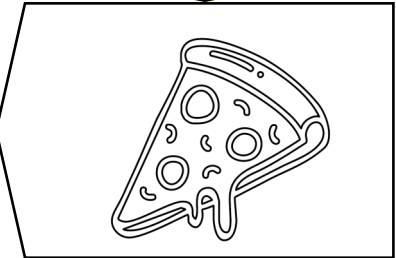
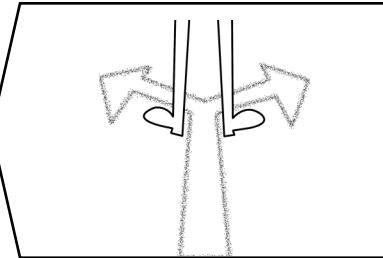
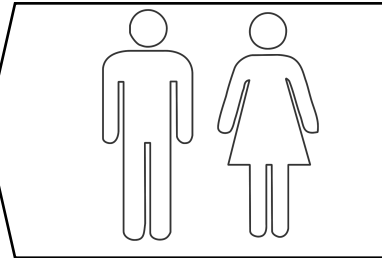
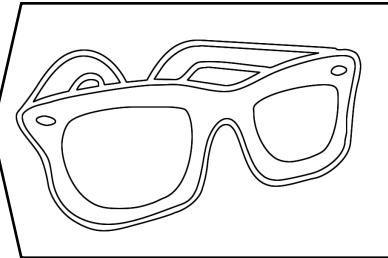
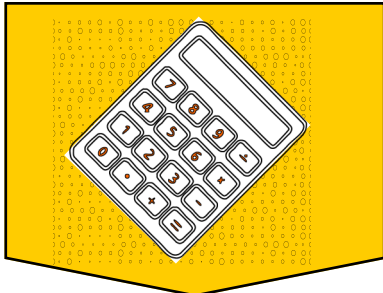
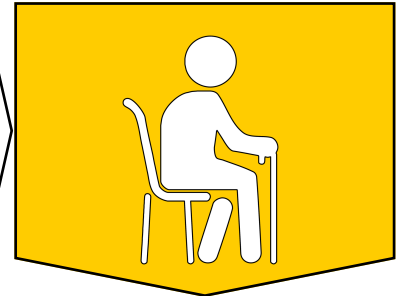
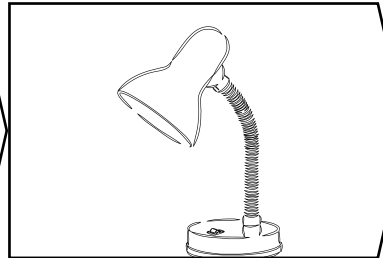
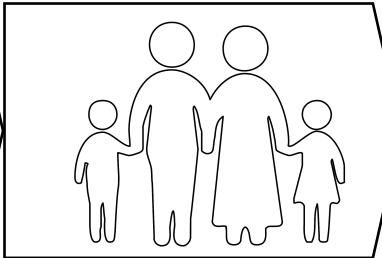
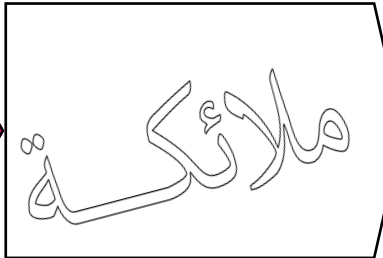
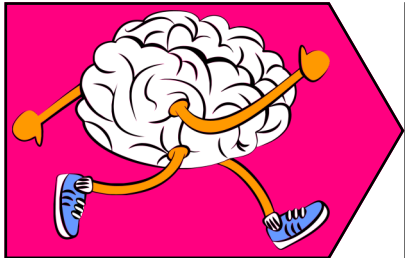
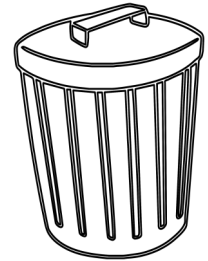
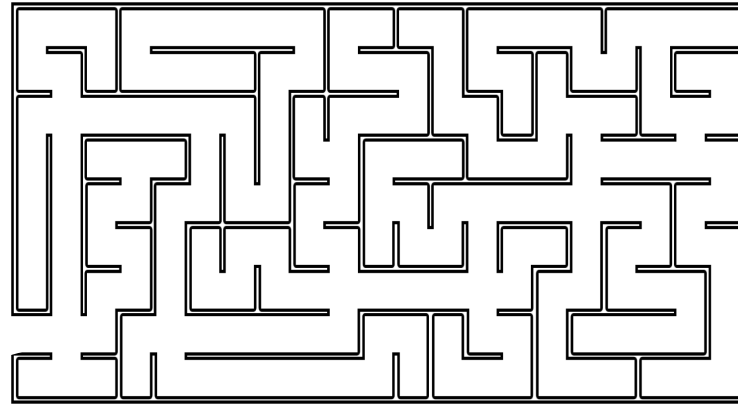

Three differences between angels and humans.

Do angels look after their families?

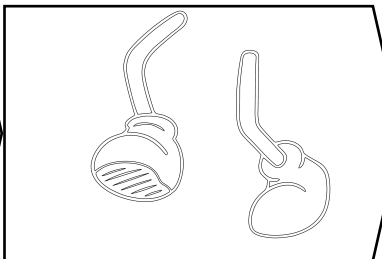

What is freewill?

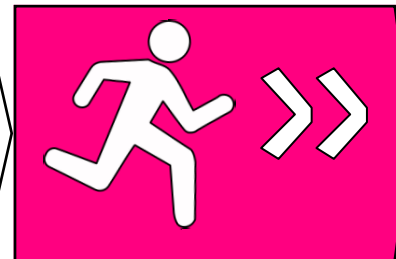

# Angel Jibrael

delivered the messages from  
Allah to the prophets



It was the duty of  
Angel Jibrael to bring  
the Qur'an to Prophet  
Muhammad ﷺ.

Angel Jibrael جبرائيل  
brought Wahi to  
all the prophets.

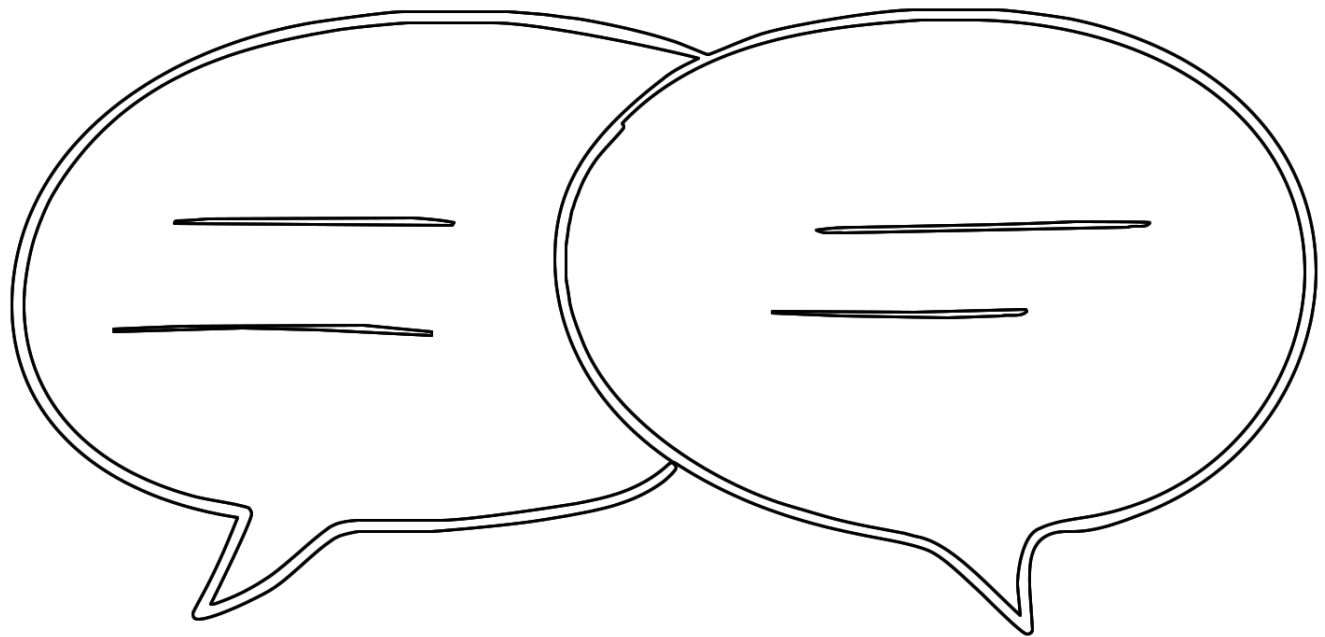

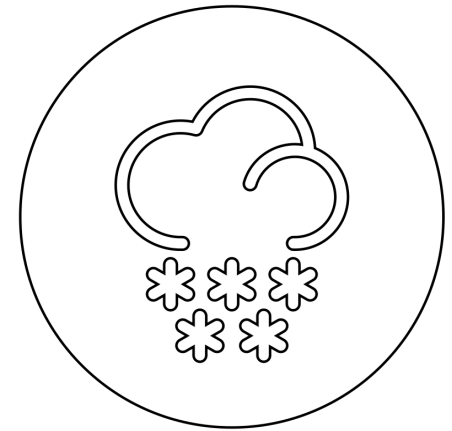
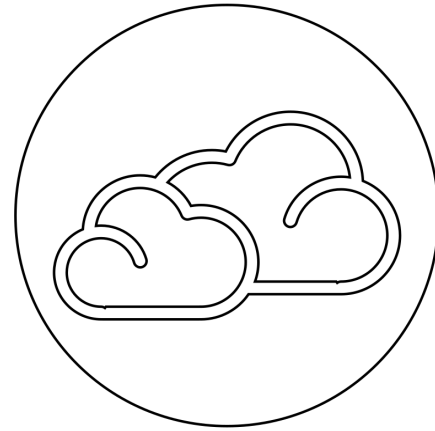
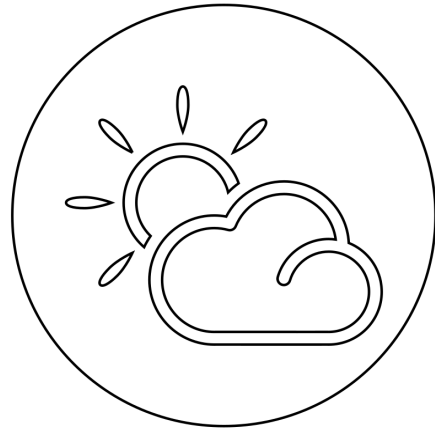
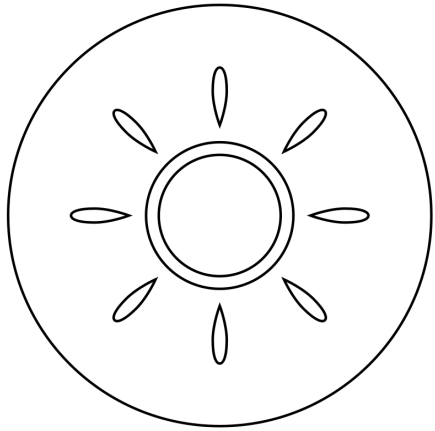

Angel Mikaeel is in  
charge of rain

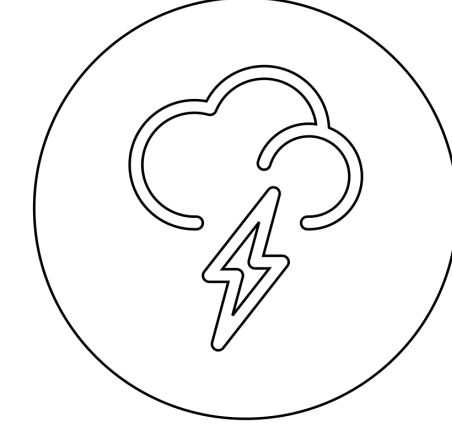
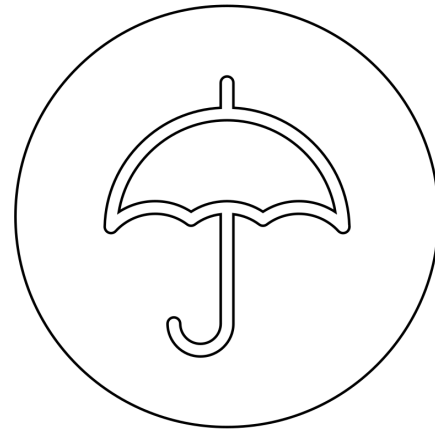
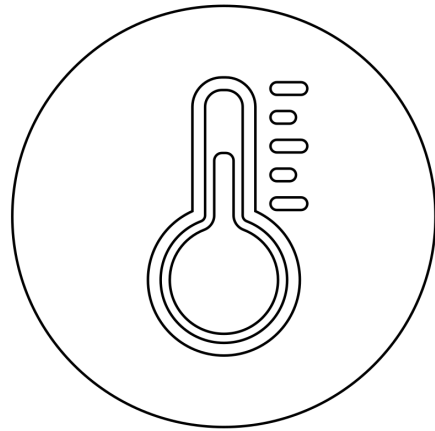
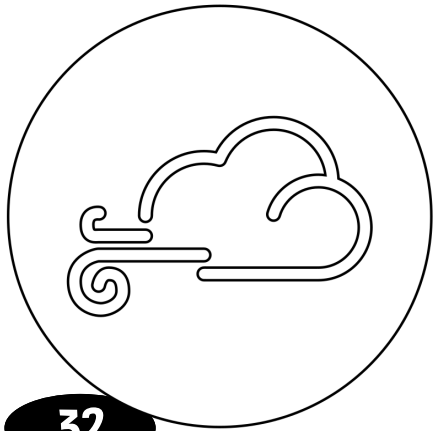

# Angel Ridwan is the guardian of Jannah

Good people  
are rewarded  
with Jannah

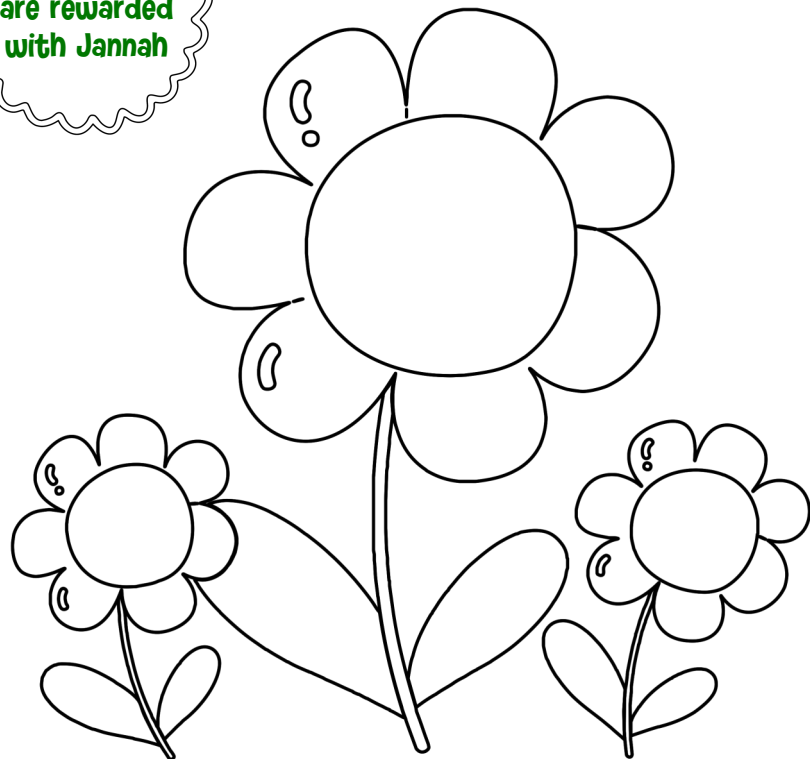

Bad people  
are punished  
with  
Jahannam



ANGELS

# Angel Malik is the guardian of Jahannam

The Angels known as

# Kiraman Katibeen

Write down your good and bad deeds

◀ The angel on the **Left side** writes your **bad deeds**.

▶ The angel on the **right side** writes your **good deeds**.

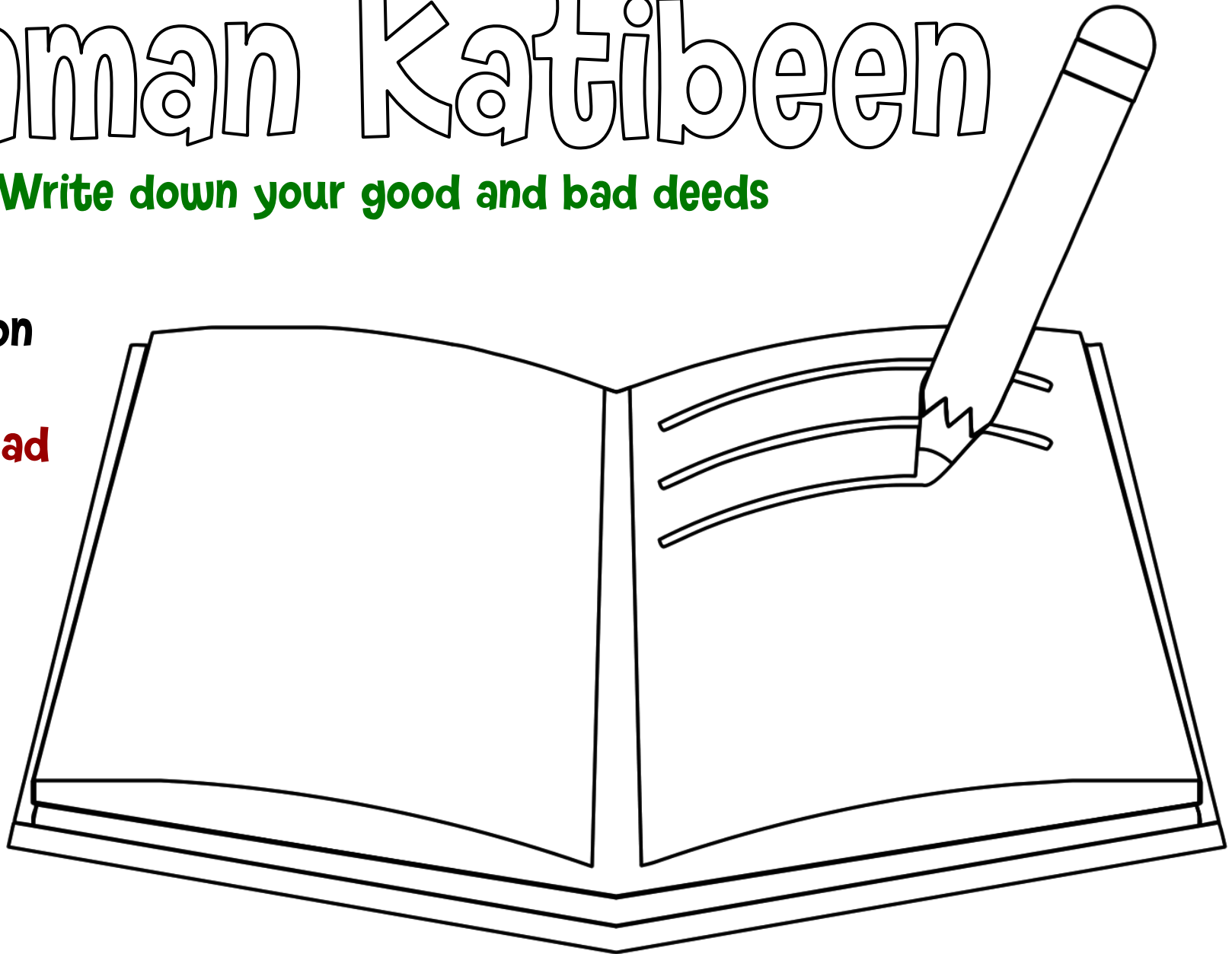

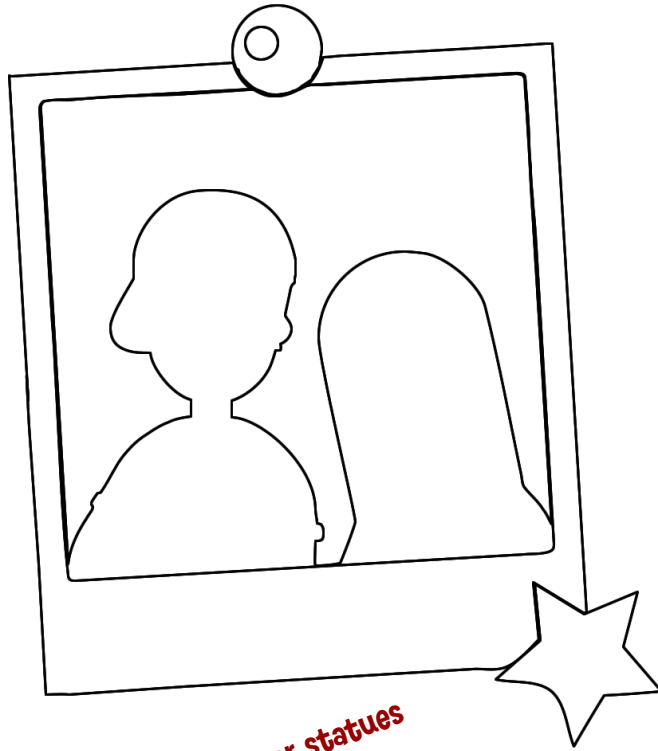

# Angels of Rahma

(Angels of Mercy)

ANGELS

*Pictures or statues  
of living things  
(animals or humans)*

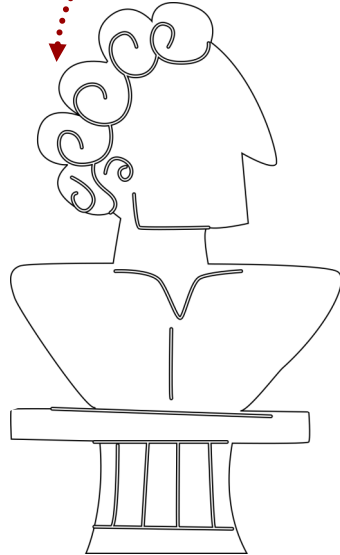

Do not enter a house  
where there are pet  
dogs or pictures of  
living things.

*Working dogs  
such as guide  
dogs are ok*



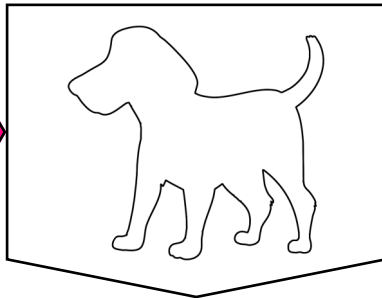
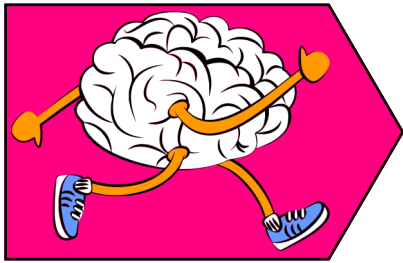

# WORD FIT

1. Angels are not male or \_\_\_\_\_.
2. Angels don't need rest or \_\_\_\_\_.
3. Angels don't have a f\_\_\_\_\_.
4. Jibrael عليه السلام sometimes came as a \_\_\_\_.
5. Angels can be different \_\_\_\_\_ and sizes.
6. Angels don't need to eat or \_\_\_\_\_.
7. We can't \_\_\_\_ Angels.
8. Angels are made of \_\_\_\_\_.
9. Allah made a countless \_\_\_\_\_ of Angels.
10. Angels don't have \_\_\_\_\_ so they can't choose.

Sometimes Angel Jibrael عليه السلام would come with the revelation of the Qur'an in the form of a man – the handsome Sahabi Dihya Kalbi رضي الله عنه.

**Kiraman  
Katibeen**

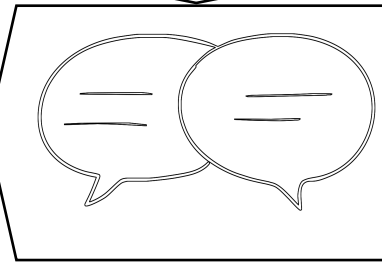

Which Angels don't come to a house where there are pictures of people?

Which Angel is in charge of Jannah?

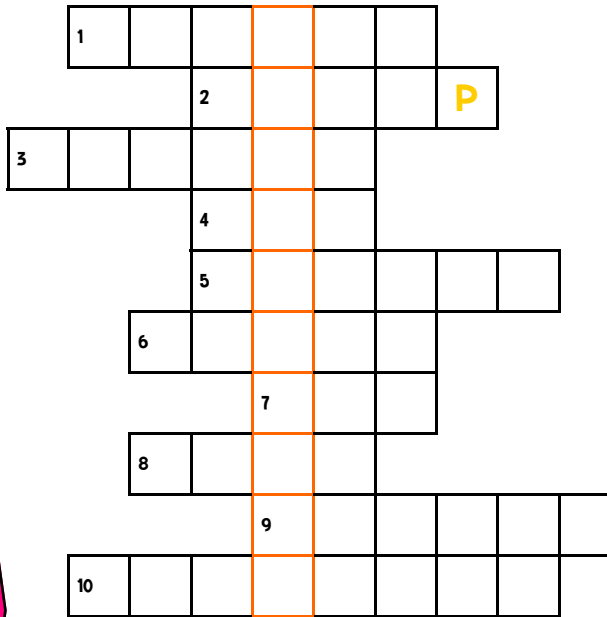
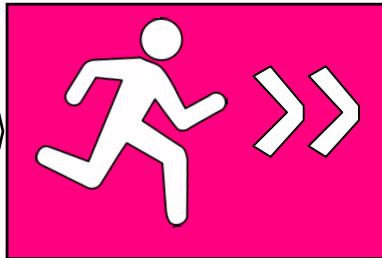
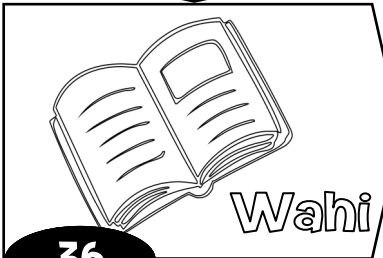
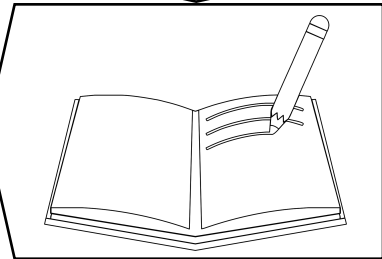
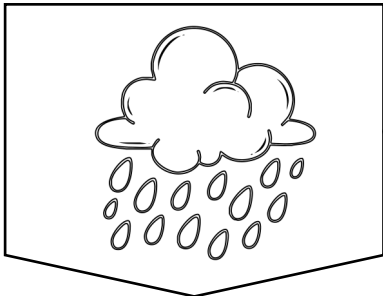

**Secret message**

**THINKING** The Angels of Allah are amazing. Why didn't Allah make us like them instead?

The Angels don't have Free will so they have to obey Allah and can't choose.

If a human chooses to obey Allah from his or her own Free Will then they have done a greater act.

This is why humans can be greater than angels by using this amazing gift of free will.

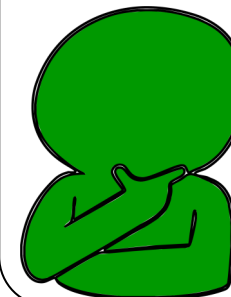

If we make a bad choice and we are truly sorry, then we can ask Allah for forgiveness.



# Angel Izraeel

Takes the soul of a  
person when they die

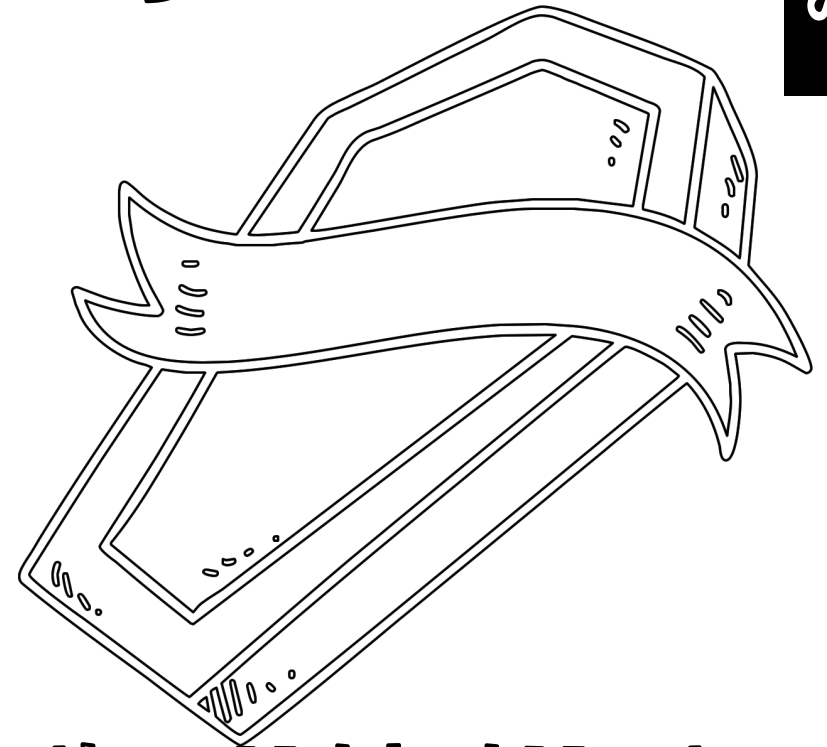
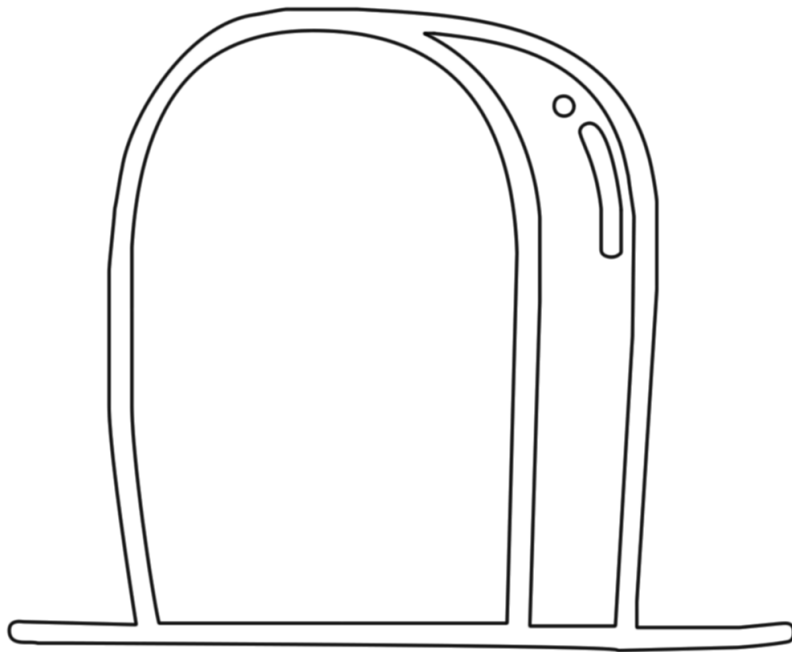

He is also know as the Angel of Death or Malak al Mawt

# MUNKAR & NAKEER

Question a person in their grave

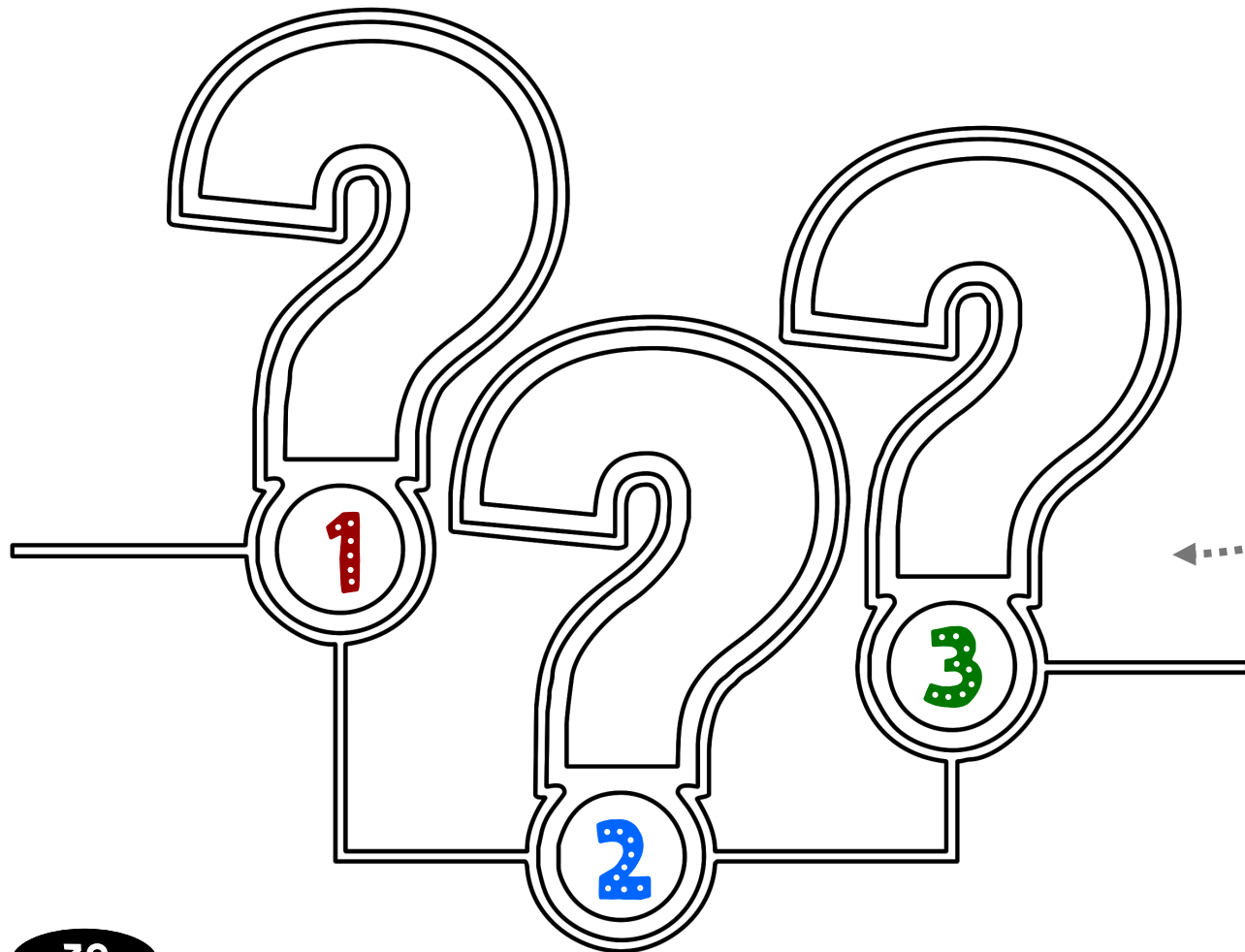

- ① Who is your Lord?
- ② What is your religion?
- ③ Who is your Prophet?

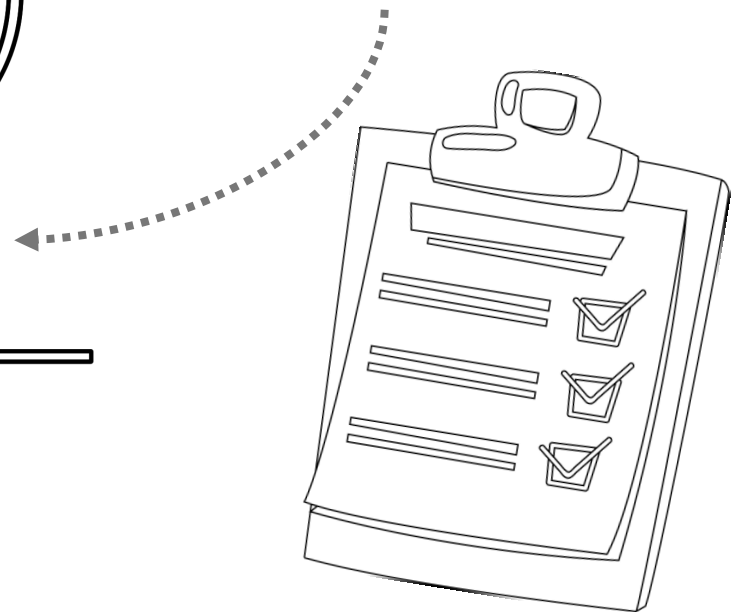

# Angel Israfeel



blows the trumpet  
on the Last Day

When the trumpet is blown, everything will come to an end

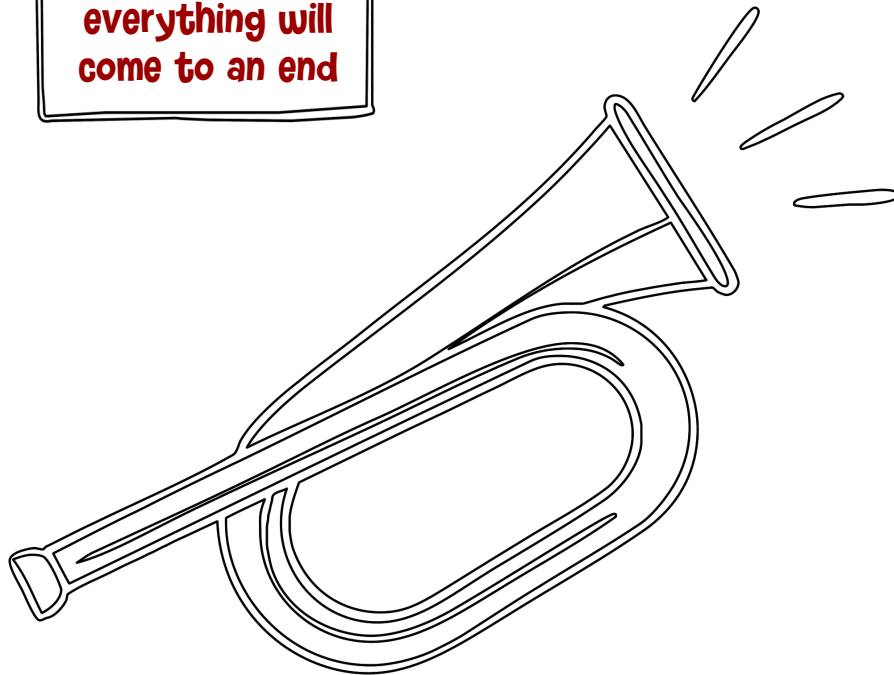

When Angel Israfeel blows the trumpet a second time, everyone will be brought back to life.

# Angels

**Make DUA for a person who is on a journey to gain knowledge.**

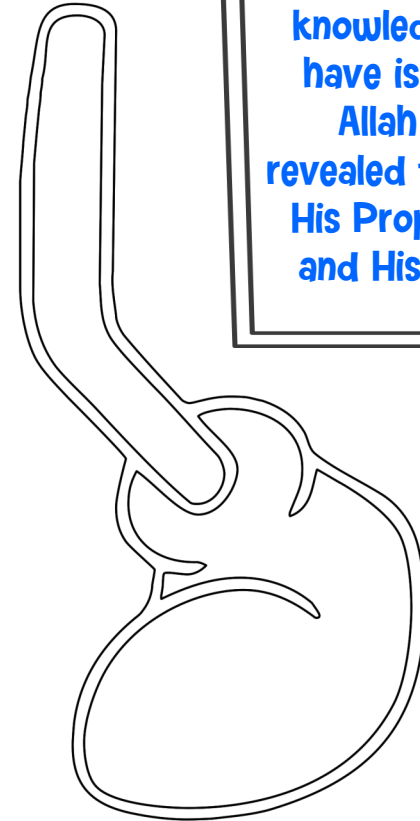
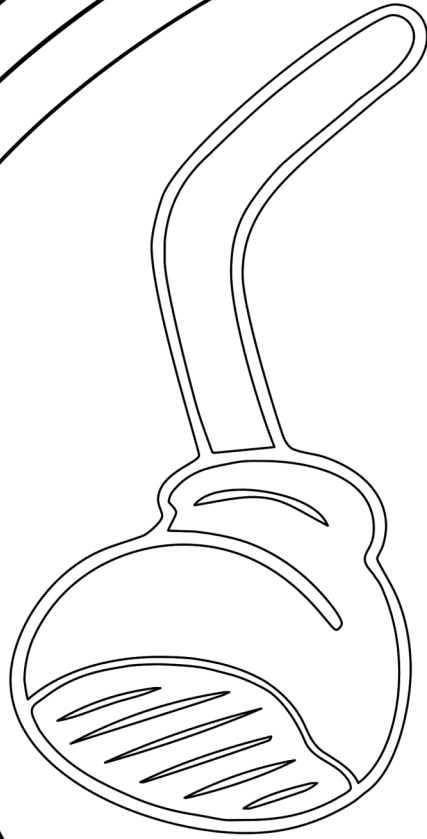
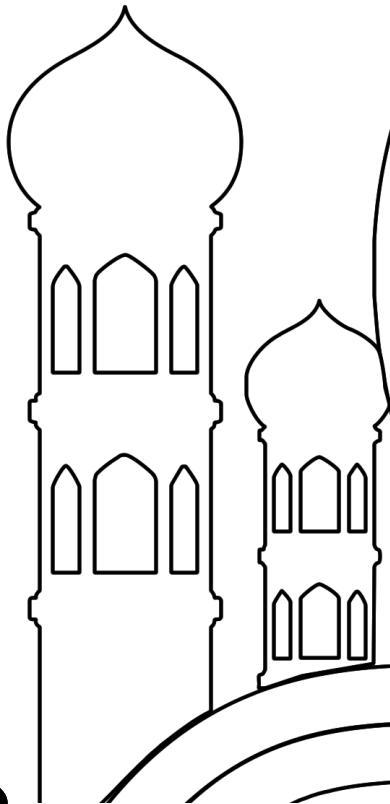

## THINKING

The Angels are from the unseen. We have so little knowledge about the unseen.

In fact, the only knowledge we have is what Allah has revealed through His Prophet ﷺ and His Book.

# WORD FIT



If you know the jobs of each Angel mentioned, then fit them in the grid.

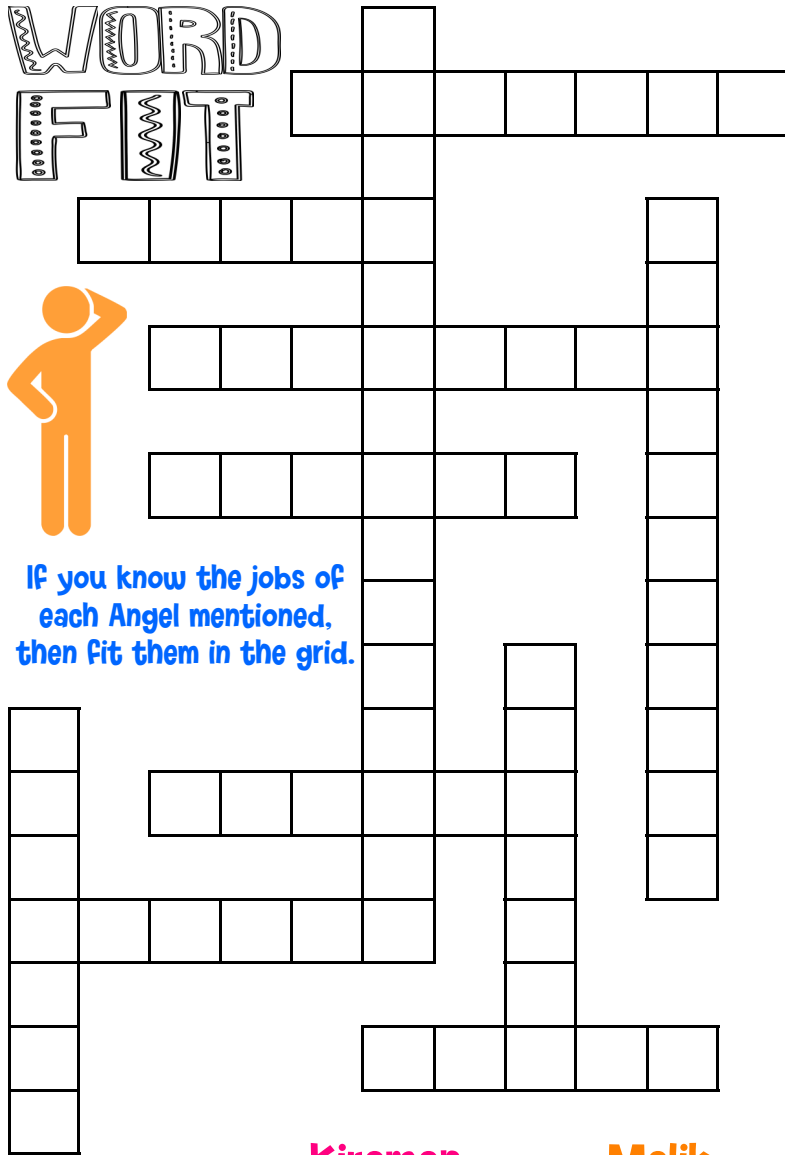

Israfeel  
Izraeel  
Jibrael

Kiraman-  
Katibeen  
Malak-al-  
Mawt  
Mikaeel

Malik  
Munkar  
Nakeer  
Rahma  
Ridwan

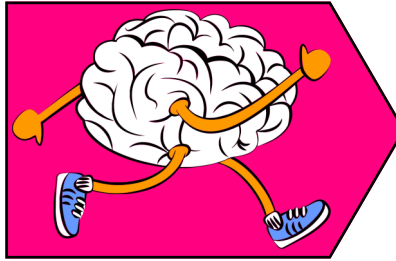

Which Angel takes the soul when the person dies?

Malak Al Mawt

Angels of Rahma

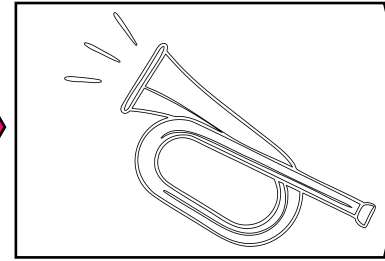
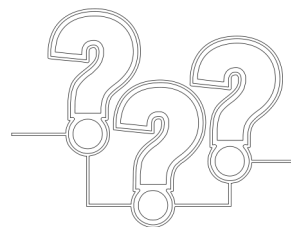

Which Angels question a person in their grave?

Angel Ridwan

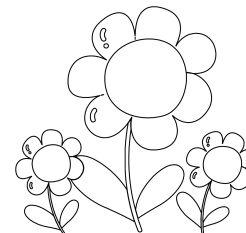

Angel Malik

Which Angel is in charge of Jahannam?

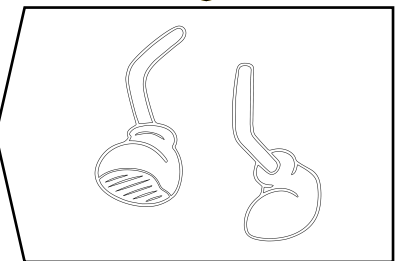
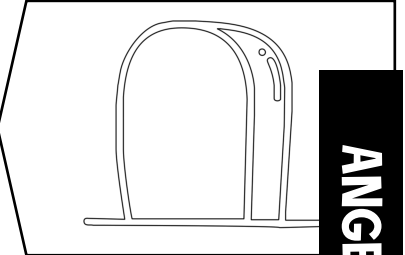

ANGELS

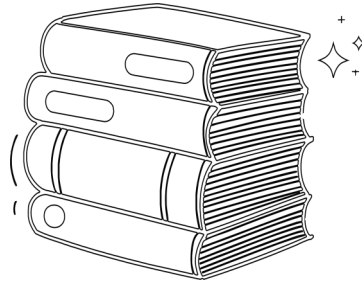

# Books

Allah gave some Prophets  
books to guide their people

# The four main books (kitaab) are:



**Tawrah**  
Torah

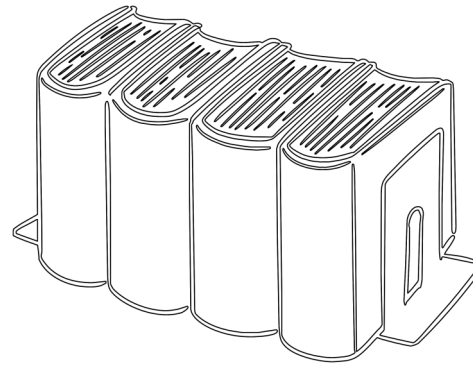

**Zaboor**  
Psalms



**Injeel**  
Gospel



**Qur'an**  
The Last Book

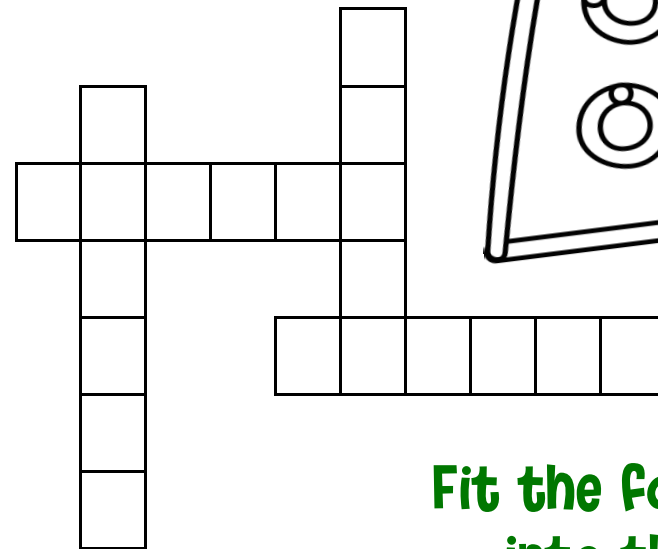

Fit the four books  
into the grid

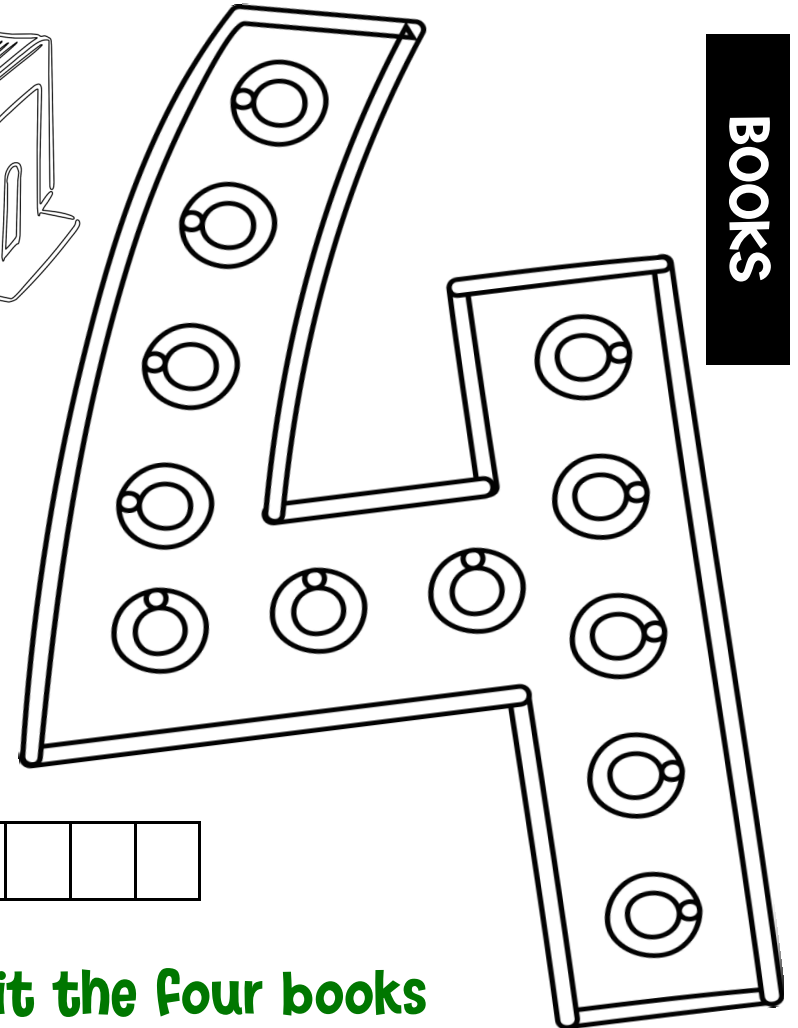

BOOKS

# Books of Allah

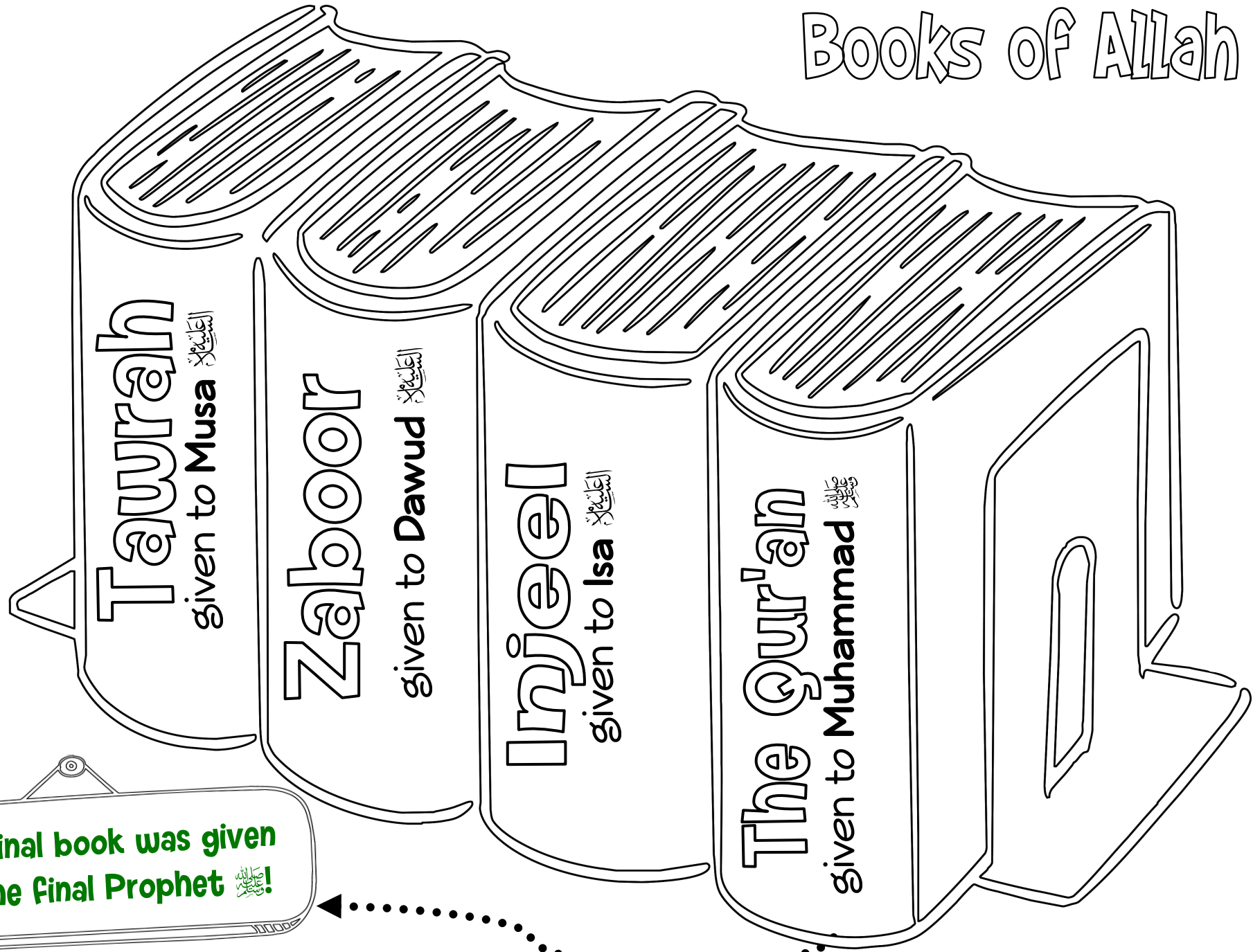

The final book was given to the final Prophet ﷺ!



# Some Prophets were given smaller books

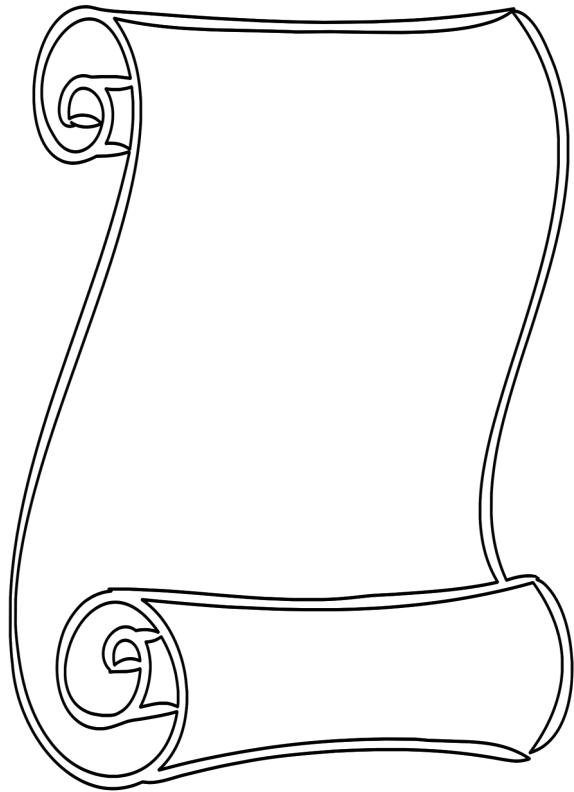

(Sahifahs)

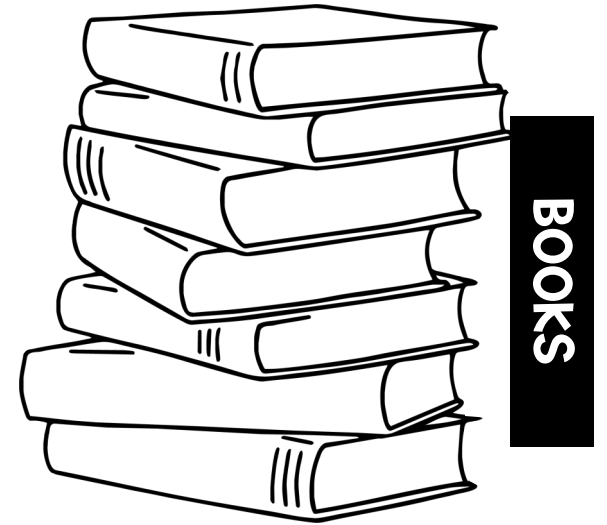
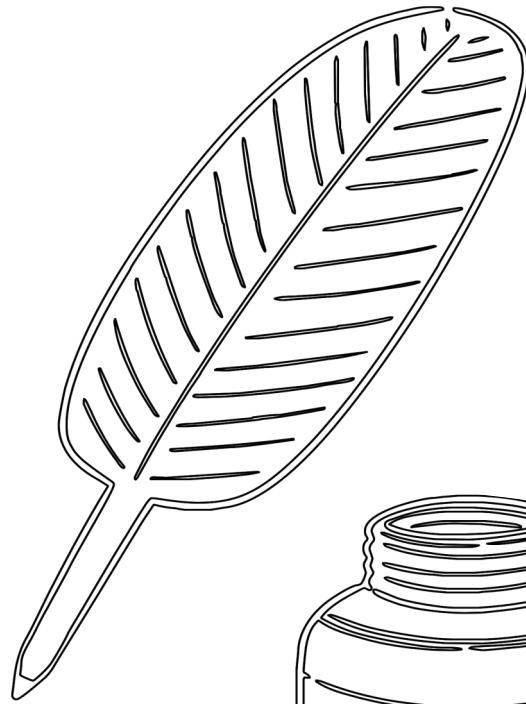

- ① Ibrahim عليه السلام
- ② Adam عليه السلام
- ③ Sheeth عليه السلام
- ④ Idrees عليه السلام

# The Qur'an

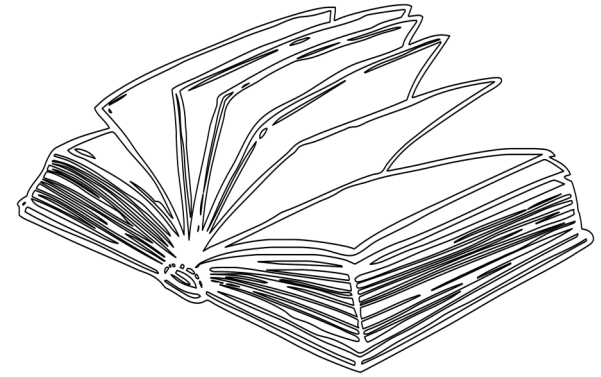

has **NEVER** been changed

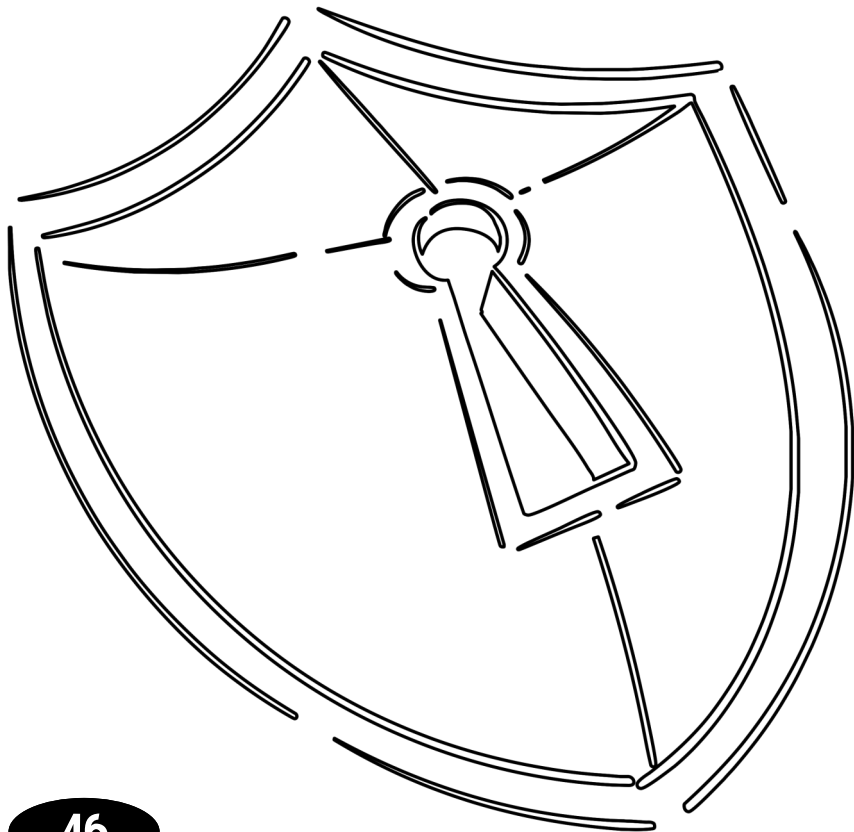

The other books were protected by the followers of their prophet. The Qur'an is protected by Allah.



The other books were sent only for the people (or nation) of the prophet. The Qur'an was sent for mankind.



The followers of other religions and books should all be following the Qur'an and Prophet Muhammad ﷺ.

# Millions of People have memorised the Qur'an by heart

**Hafiz (male)**  
**Hafiza (female)**  
**Huffaz (plural)**

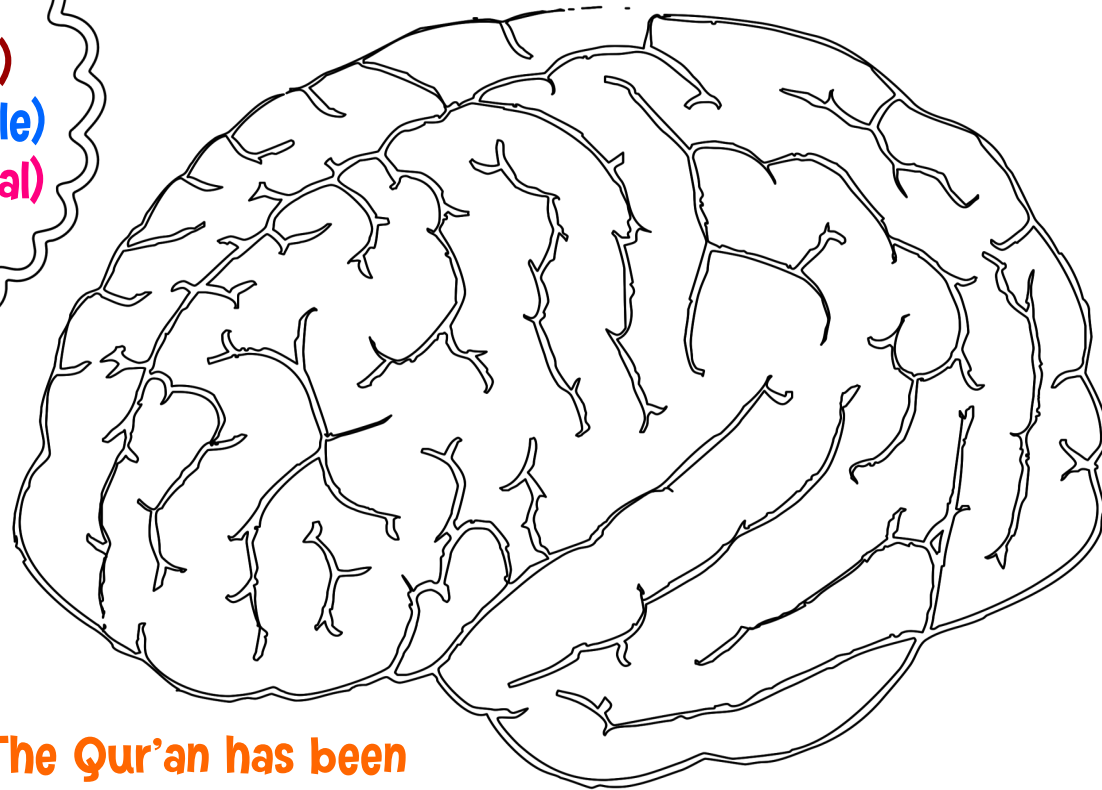

From the time  
of Prophet  
Muhammad ﷺ  
until today,  
there is an  
unbroken chain  
of Huffaz.

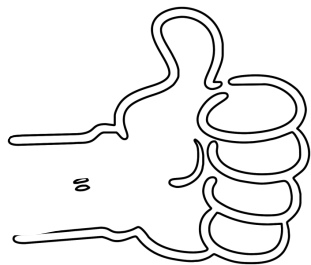

The Qur'an has been  
protected in the hearts of  
people and in writing!

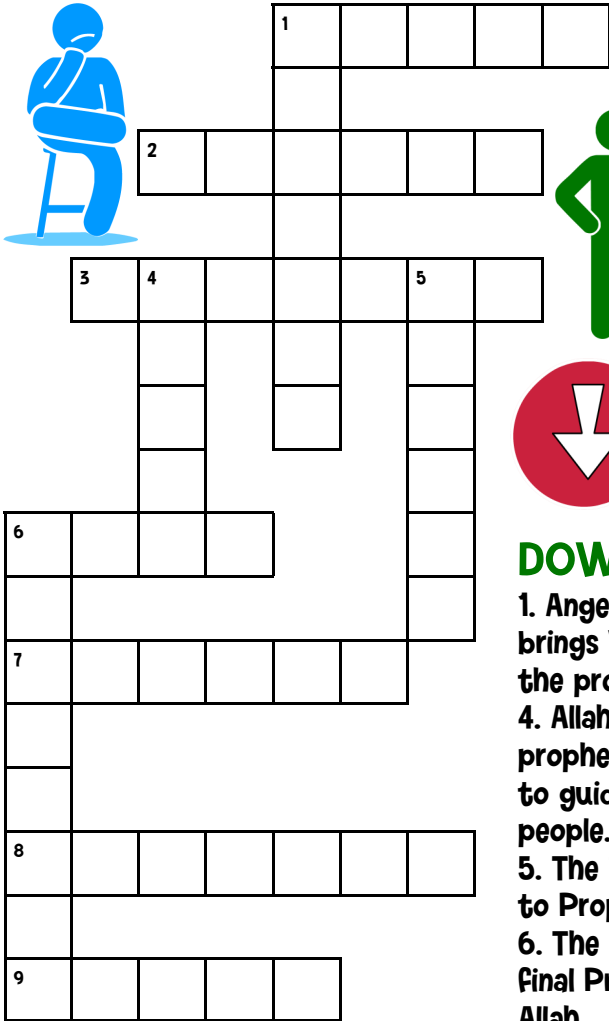

### DOWN

1. Angel \_\_\_\_\_ brings Wahi to the prophets.
4. Allah gave some prophets \_\_\_\_\_ to guide the people.
5. The book given to Prophet Isa عليه السلام.
6. The last and final Prophet of Allah.

### ACROSS

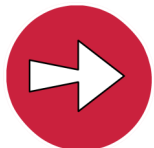

1. Prophet Isa عليه السلام is also known as \_\_\_\_\_.
2. The book given to Prophet Dawud عليه السلام.
3. Prophet \_\_\_\_\_ عليه السلام was given a smaller book (Sahifah).
6. Prophet \_\_\_\_\_ عليه السلام was given the tawrah.
7. People who have memorized the Qur'an.
8. The Qur'an is guidance for all \_\_\_\_\_.
9. Prophet \_\_\_\_\_ عليه السلام was given the Zaboor.



CROSSWORD

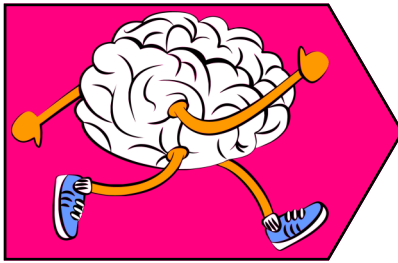

**Name some prophets who were given smaller books**

**The difference between the Qur'an and the other books.**

**Which is the only preserved Book of Allah?**

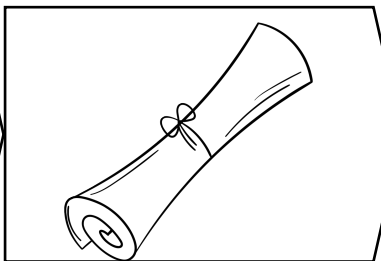
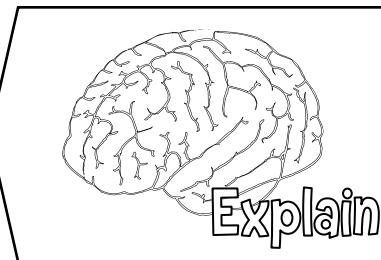
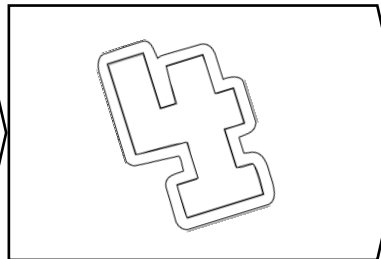
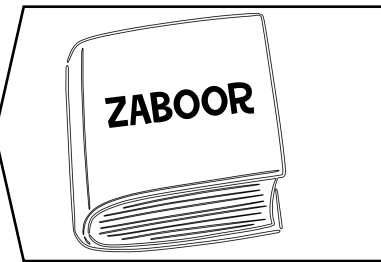
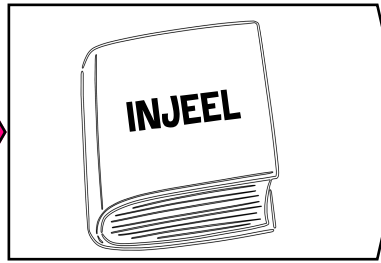
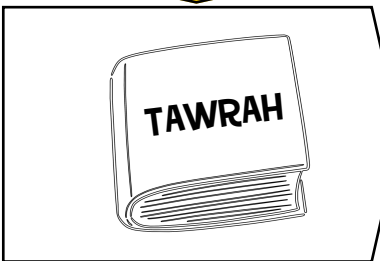

**Why did Allah give some prophets books?**

**Which book was given to Prophets Muhammad عليه السلام, Musa عليه السلام, Isa عليه السلام and Dawud عليه السلام?**

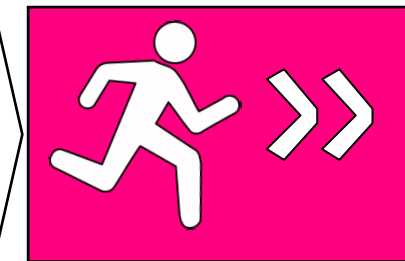
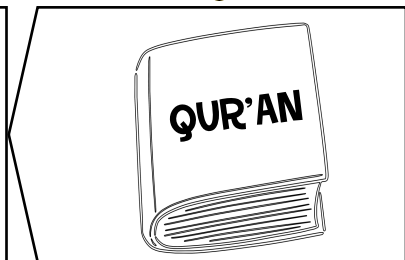
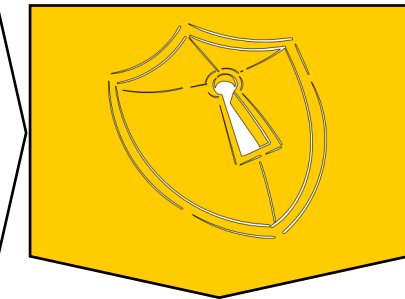

# The First Verses

Angel Jibrael عليه السلام gave the **first five verses** of the Qur'an to Prophet Muhammad صلى الله عليه وسلم in cave Hira.

Cave Hira is on Mount Noor in Makkah

The first word the Angel Jibrael said was "Iqra!" which means read.

Prophet Muhammad صلى الله عليه وسلم was 40 years old when Angel Jibrael came to him with the verses and told him he was a prophet of Allah.

The  
Qur'an  
was  
revealed  
over

*The other books were  
revealed all at once.*



# The Qur'an was revealed in

# Arabic

The Arabic language was at its best at the time of Prophet Muhammad ﷺ. The Arabs were experts in the language.

When they heard the amazing verses of the Qur'an, they knew that the words were from Allah.

They knew that Muhammad ﷺ was a true prophet of Allah.

For every letter recited we get ten thawabs (hasanah/rewards)

BOOKS

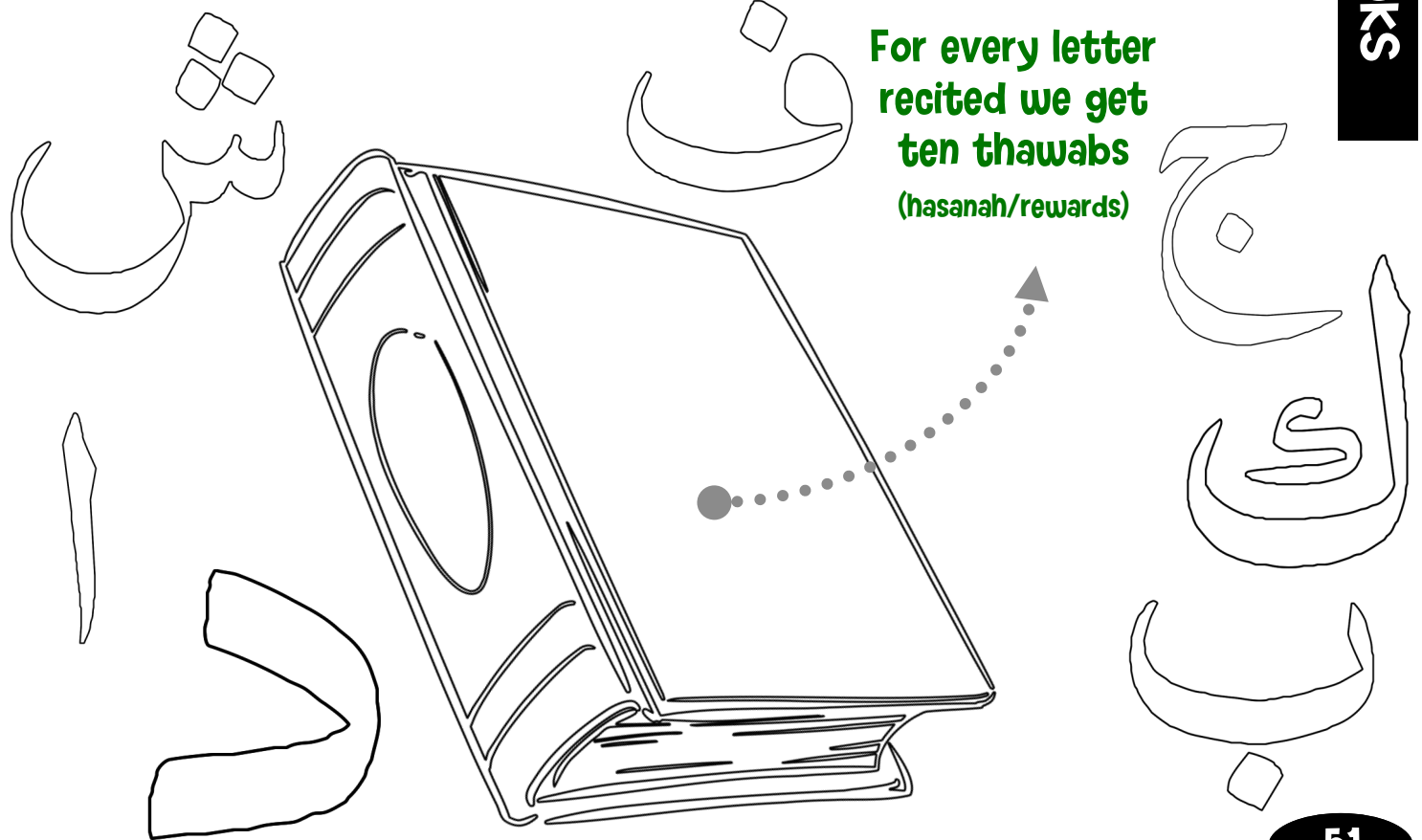

The Qur'an is

Free of all

errors

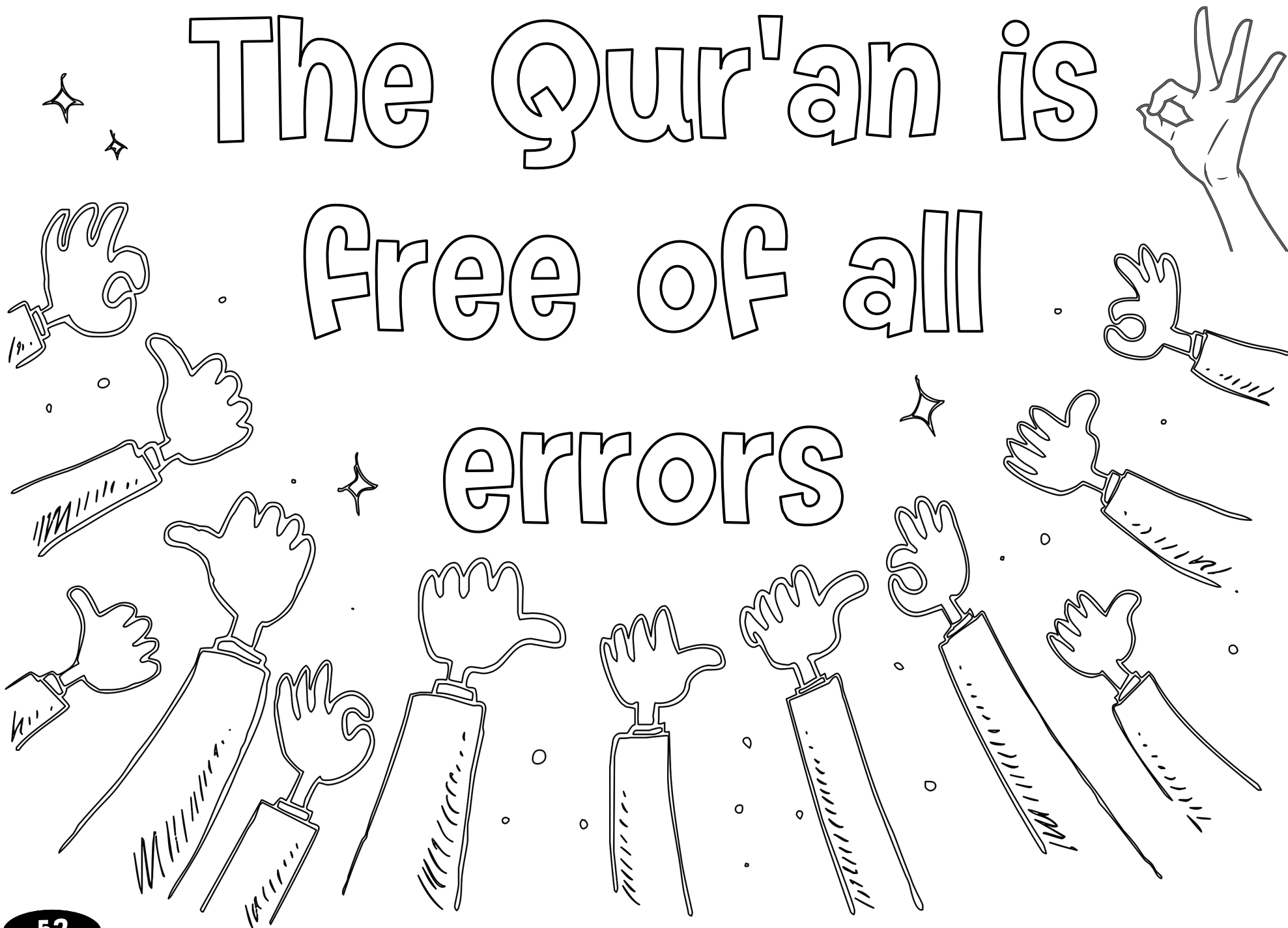



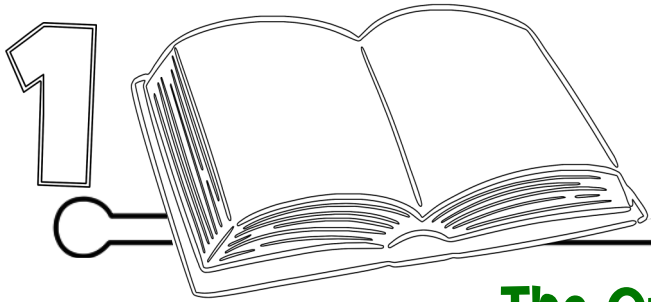

The Qur'an is



guidance

2

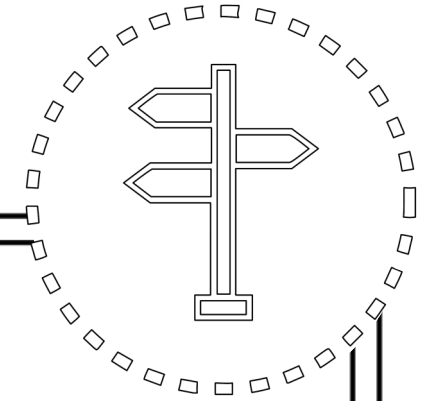

3

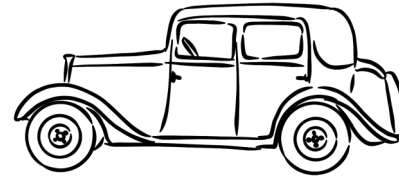

for all mankind



4



until the Day of Judgement

# Qur'an Facts

## Facts

- 🎯 **114 Suwar**
- 🎯 **30 Paras**
- 🎯 **Over 6500 verses**

Plural of Surah

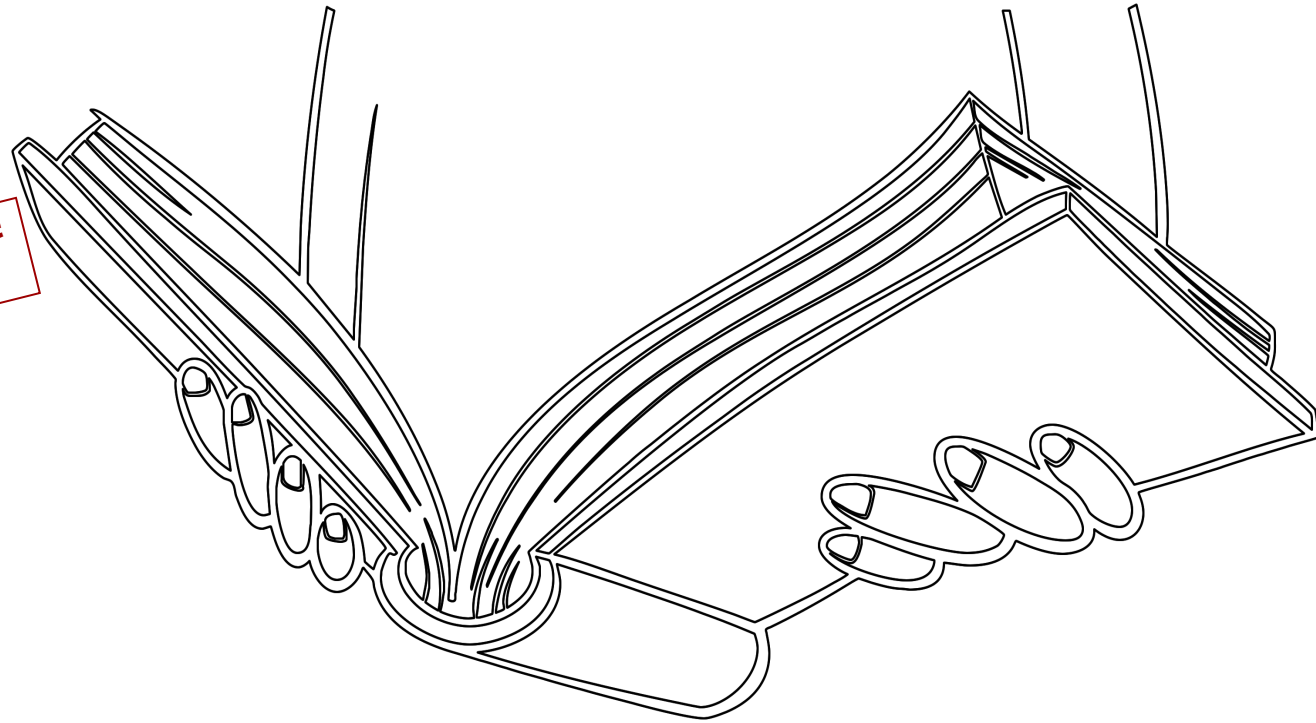

## Surahs

- 🎯 **Al-Baqarah – the longest Surah (286 verses)**
- 🎯 **Al-Kawthar – the shortest Surah (3 verses)**
- 🎯 **Al-Fatiha – most recited Surah**
- 🎯 **Yaseen – the heart of the Qur'an**

The Qur'an tells us stories from the past so that we may learn lessons from them. With recent archaeological discoveries, these stories are shown to be accurate.

Amina is visiting Topkapi Museum Help her find her way there.



Topkapi Museum in Istanbul (Turkey) has many ancient Islamic artefacts including one of the oldest copies of the Qur'an.

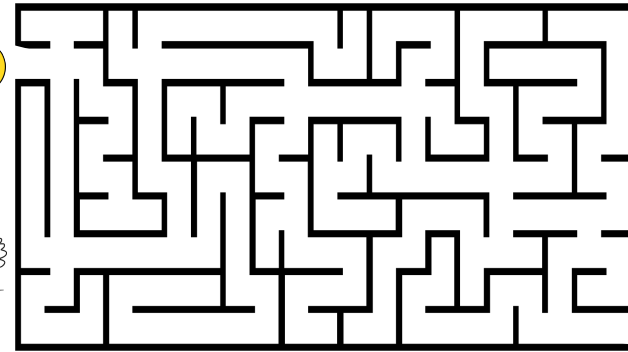
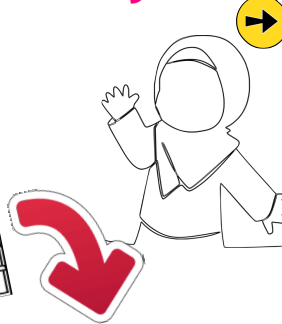

**BOOKS**

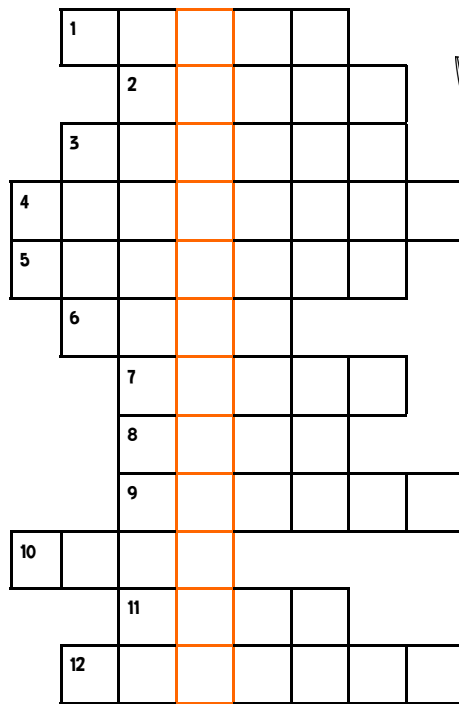

**WORD FIT**

The Qur'an gives us advice and guidance on how to live our lives. This advice is valuable and essential for an individual's and community's well-being. This includes physically, mentally and spiritually.

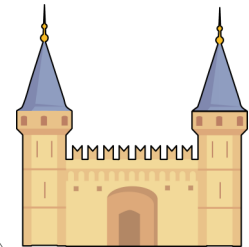
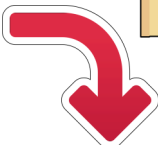

1. The \_\_\_\_\_ was given to our Prophet ﷺ.
2. Surah Yaseen is the \_\_\_\_\_ of the Qur'an.
3. The Qur'an was revealed in \_\_\_\_\_.
4. The Qur'an is g\_\_\_\_\_ for everyone.
5. Allah will \_\_\_\_\_ the Qur'an from changes.
6. The Qur'an is \_\_\_\_\_ (revelation) from Allah.
7. The Qur'an was revealed over 23 \_\_\_\_\_.
8. The Arabic word \_\_\_\_\_ means read.
9. Al-f\_\_\_\_\_ is one of the names of Qur'an.
10. \_\_\_\_\_ main books were revealed.
11. The Qur'an is the \_\_\_\_\_ book given to the \_\_\_\_\_ prophet.
12. The Qur'an is for the whole of \_\_\_\_\_.

The Qur'an tells us about the future which has been entirely accurate. This shows us that the information is from Allah alone. Other people have made predictions and prophecies that have been vague and often wrong.

**Secret Message**

# Story Time

The people were so surprised. I would say they were actually shocked. Prophet Muhammad ﷺ recited some words, and these were eloquent and beautiful. More incredible than anyone had ever heard before!

This man, Muhammad ﷺ, who had never recited a word of poetry before, said that they were the words of Allah.

This man, Muhammad ﷺ, was 'unlettered' and couldn't read or write. There were no schools in those days, and very few people

could read or write.

Where could he possibly get these verses? The Arabs loved Arabic and were indeed the experts in their language. They knew that this was far superior to anything they had heard before in their entire history.

They called Walid ibn Mughirah one of their leaders. He was one of the best poets and so well educated. He knew all types of Arabic poetry and was a genius poet himself.

He was so good that often, they would hang his poems inside the Ka'bah. Only the absolute best poems were put in the Kab'ah.

Walid was told to go and listen to Prophet

Muhammad ﷺ and tell them where he got such masterpieces of words from.

Walid went to listen to the Qur'an from Prophet Muhammad ﷺ as the Makkans waited patiently outside.

Walid listened to Prophet Muhammad ﷺ recite the Qur'an and was amazed to his very core. It was so beautiful; his heart brimmed with joy. He was at a loss for words as he listened to these beautiful verses.

He finally left the company of Prophet Muhammad ﷺ but walked right past the Makkans and into his own house. He ignored everyone around him and never came back outside. He couldn't

find the words to express what he had heard and experienced.

The people waited and waited until finally, they went into his house. They hassled him to tell them about the Qur'an. Where did Prophet Muhammad ﷺ get these verses from?

Walid said that these words were not the words of a man. They were not of this world. A human could never compose such verses!

The people loved the Qur'an and knew it was from Allah. Many people became Muslims listening to the Qur'an.

Even the enemies of Islam would secretly listen to the Qur'an being recited!

When the Qur'an challenged them to produce a book like this, they didn't respond. They knew they couldn't produce a chapter like it let alone a book. They knew that the Qur'an was miraculous and Wahi.

No one to this day has been able to produce even a chapter like that of the Qur'an, but still in awe at the recitation to this day.

This is the miracle of the Qur'an. Not everyone will appreciate how much of an amazing miracle it still is today.

People still haven't been able to produce a single chapter like that of the Qur'an.

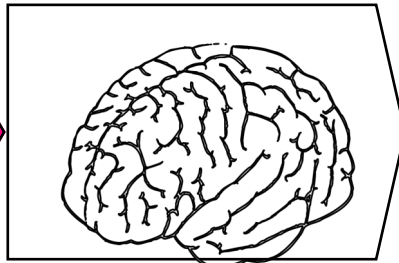
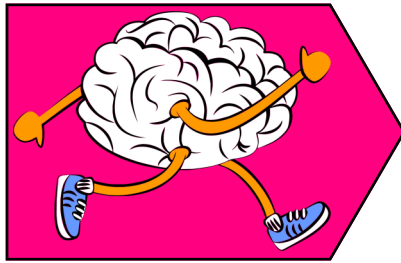

Which language was the Qur'an revealed ?

Why does the Qur'an have stories from the past?

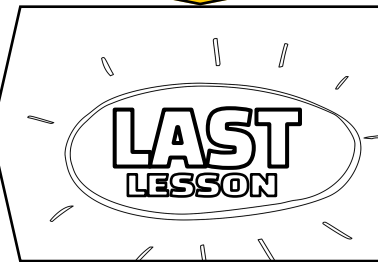

23

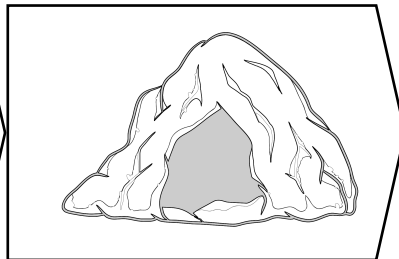

What is Wahi?

>> Suwar  
>> Paras  
>> Verses

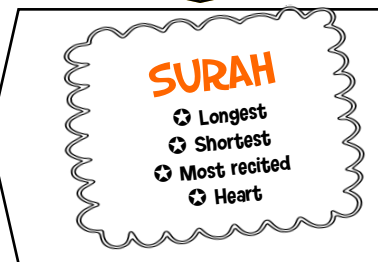
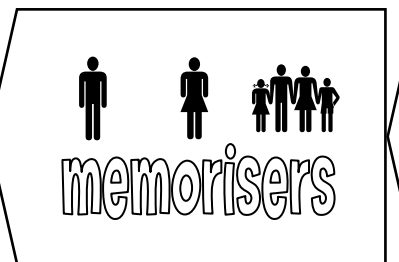

What does it mean that the Qur'an is free of errors?

How old was the Prophet Muhammad when he received the Qur'an?

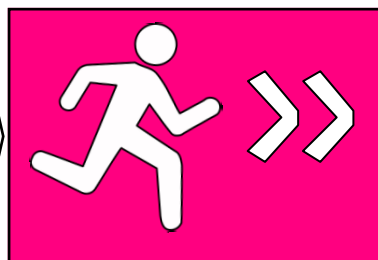

# CLEVER CLOGS

## having a CHIT CHAT

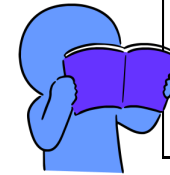

My teacher at school asked me why we read the Qur'an. I told her that it was the word of Allah and guidance for mankind.

BOOKS

You should have also mentioned that it has never been changed and is protected forever.

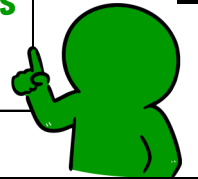

Why don't we follow other books from Allah?

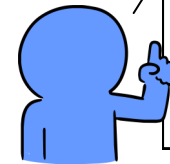

All the other books have been changed or lost. They were guidance for only their own people, not for all mankind.



# THE CORE MESSAGE OF THE QUR'AN

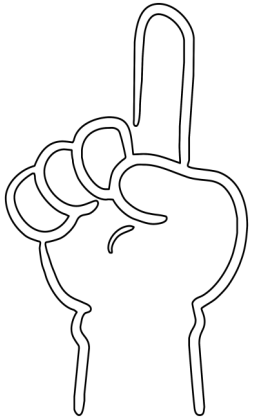

## Tawheed

Allah is One,  
without any  
partners,  
family or son.

Teaches us to  
Worship only  
Allah and  
avoid Shirk

## and

## Ibadah

Teaches us  
how to live  
our lives and  
make Allah  
happy

Choose to live  
your life  
according to  
Allah's  
guidance.



Lead a good life and Allah will  
reward you with Jannah



# The Qur'an has stories From the past

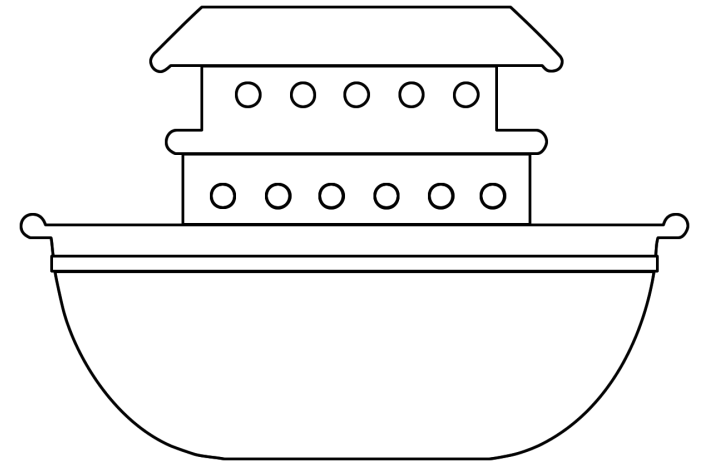
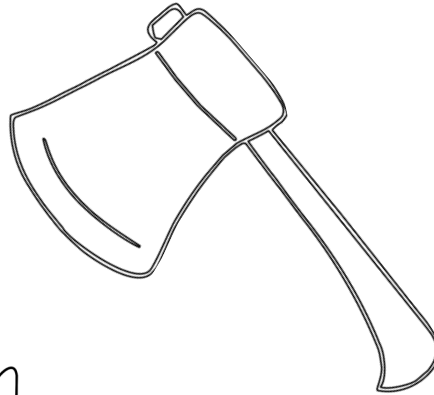
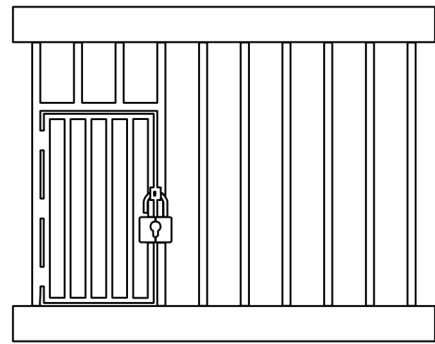
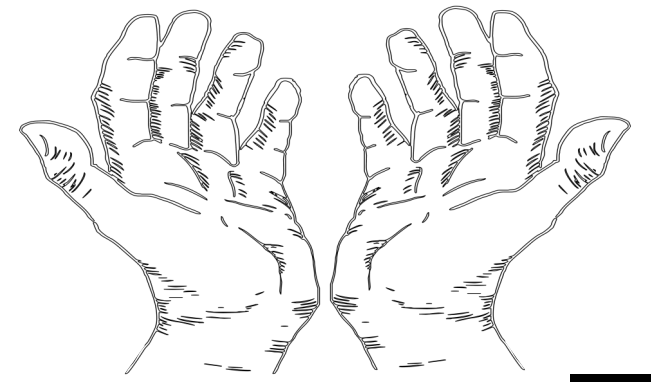

**BOOKS**

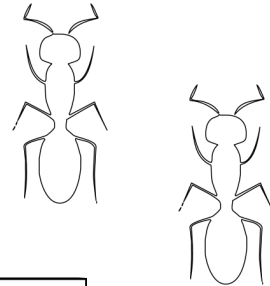
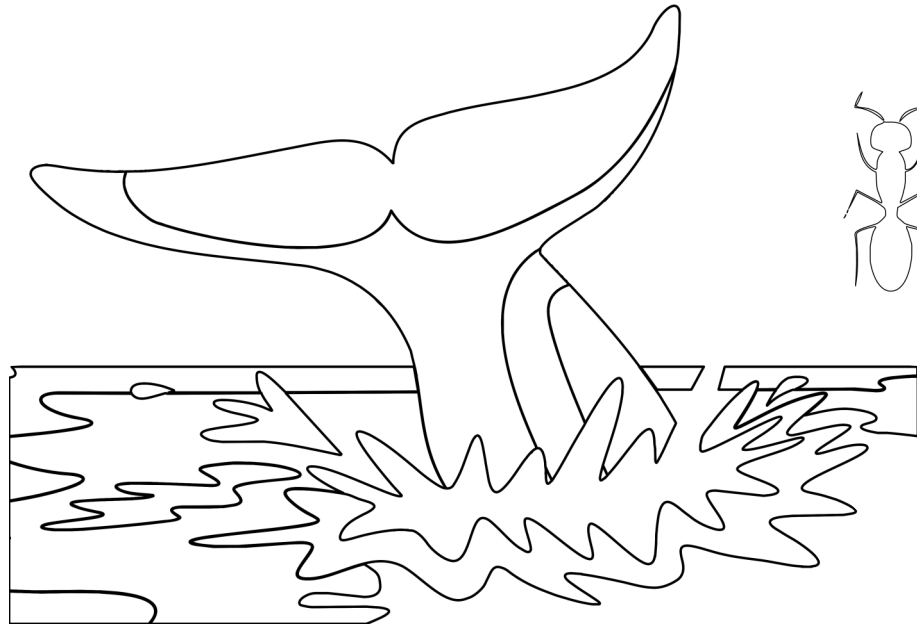

So we can learn  
lessons from them

**Sit respectfully  
don't slouch.**

**It's Wajib to listen to the  
Qur'an if it's being recited.**

**Read correctly with  
a beautiful voice.**



# Adab



**The Qur'an is the speech of Allah so  
please be respectful at all times.**

**Have wudhu before  
touching the Qur'an.**

**Always keep the  
Qur'an in a high place.**

**Do not put it on the ground  
or put your back towards  
the Qur'an.**

**Reflect upon the meanings  
and enjoy reading it!**



Some names the **Q**ur'an is also known by

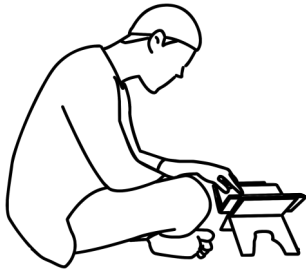

1

**Al-Qur'an**

the book that is recited a lot

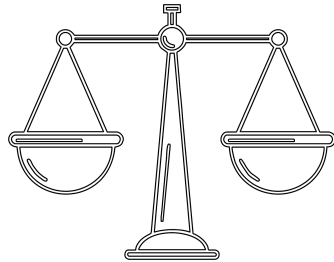

2

**Al-Furqan**

the book that tells us what is right & wrong

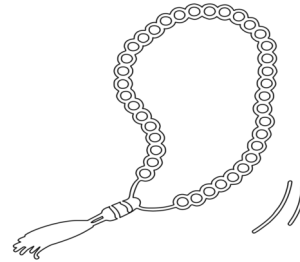

3

**Az-Zikr**

the book that is a reminder and a zikr of Allah

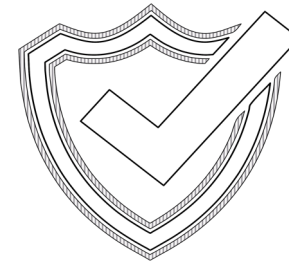

4

**Al-Kitab**

the book that is preserved forever

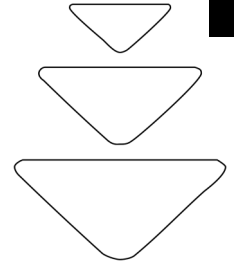

5

**At-Tanzeel**

the book that was sent down



# Amazed

Amina has broken her wudhu. Help her find the Wudhu Area in her madrasah.

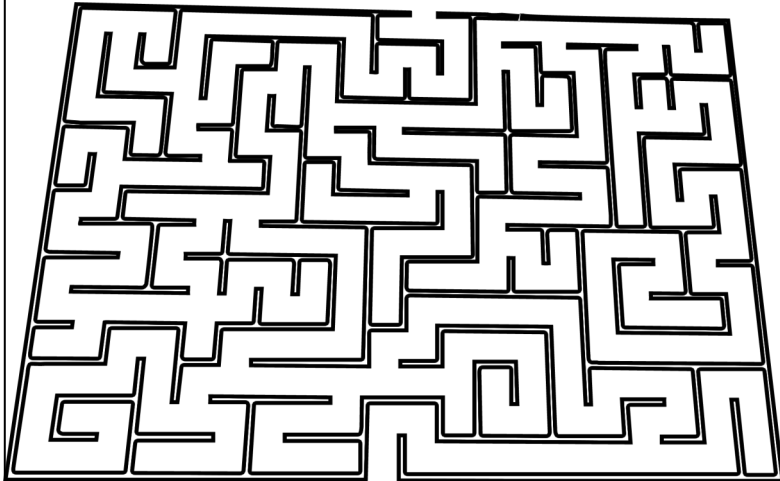

We must have wudhu before we touch the Qur'an and before we do Salah! Make sure you remain in Wudhu.



Amina needs more help, can you explain:

1. What are the 4 fard of wudhu?
2. Explain the whole wudhu process
3. What breaks the Wudhu?

Jazakallah Khayra For all your help!

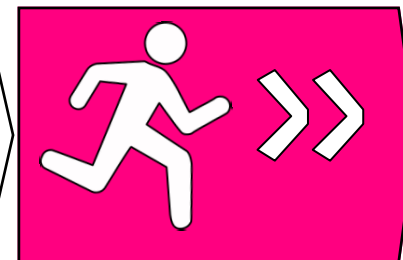
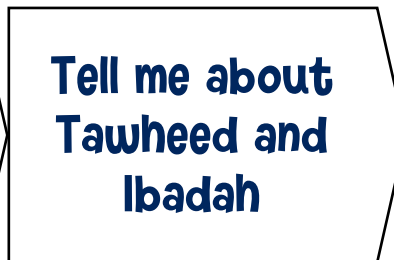
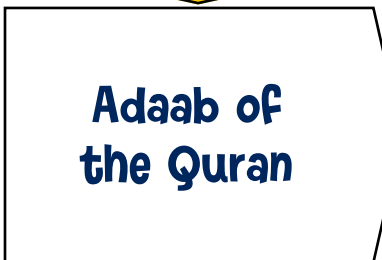
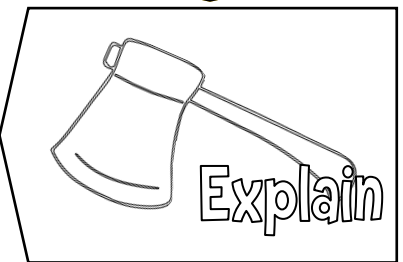
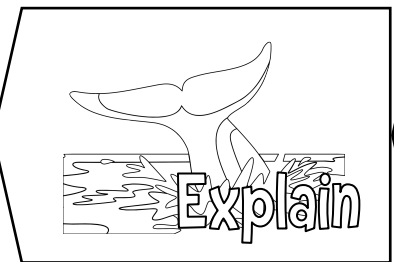
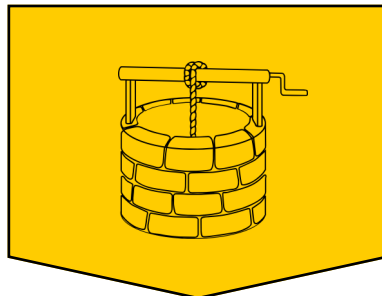
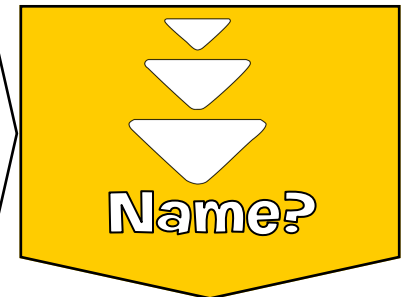
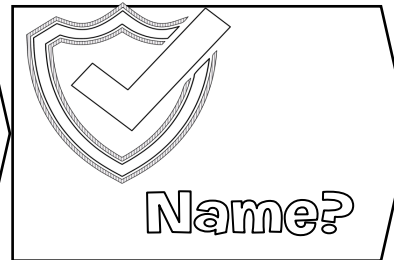
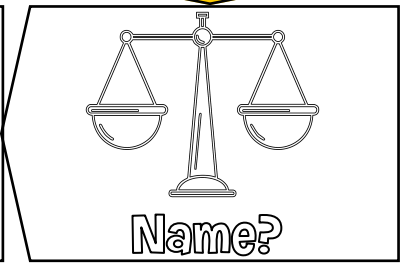
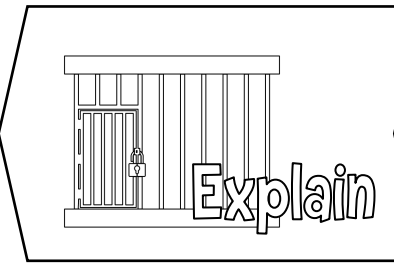
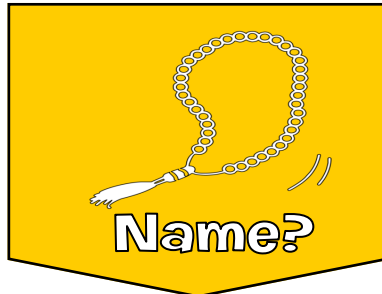
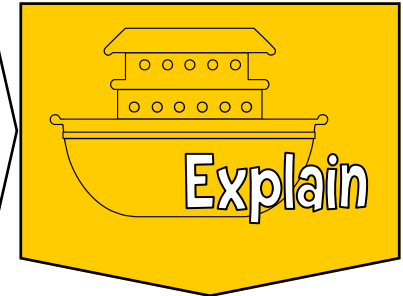
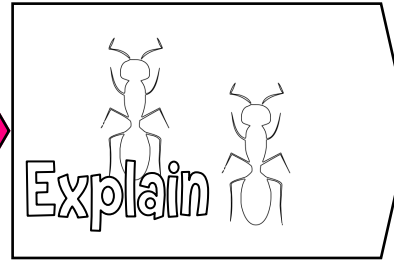
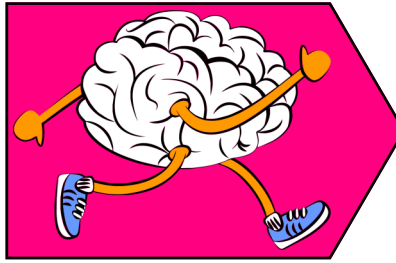

# Writing Down the Qu'ran

The verses of the Qur'an were revealed to Prophet Muhammad ﷺ and then written down by the Scribes.

The scribes wrote it down and read it back to Prophet Muhammad ﷺ.

This way they were double checked as well.

The scribes wrote it on rocks, bark from trees, large bones, animal skins..

Paper was not easily accessible in those days.

Not many people could read and write.

Prophet Muhammad ﷺ was also 'unlettered'.

# Using the Qur'an

The Muslim men and women would memorise the Qur'an and recite it every day in Salah.

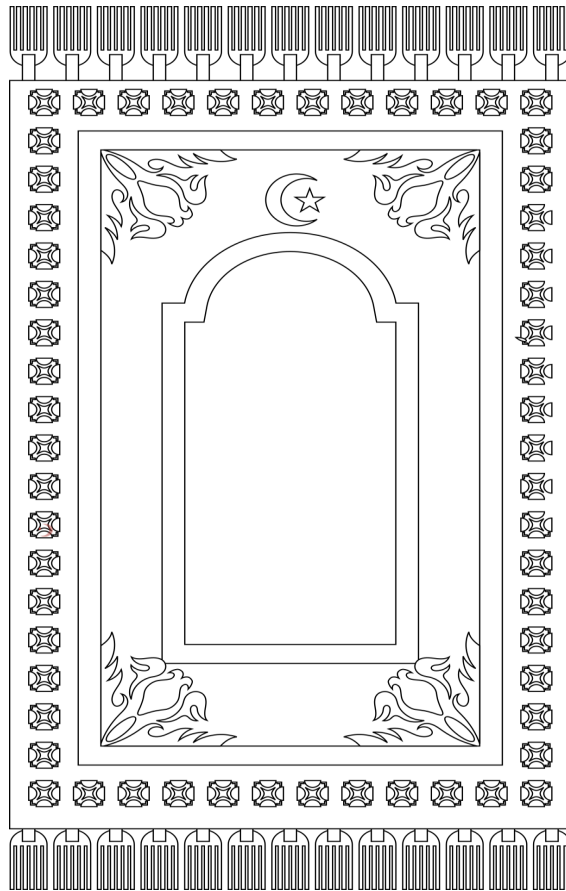

Every Muslim must memorise the Qur'an. A Muslim who memorises the Whole Qur'an is known as:

- ♥ Hafiz (Male)
- ♥ Hafiza (Female)

There were many Huffaz (plural) at the time of Prophet Muhammad ﷺ



ADAAB  
ARABIC  
GUIDANCE  
HIRA  
HUFFAZ  
IBADAH  
PROPHETS  
PROTECT  
SALAH  
SCRIBE  
TAWHEED  
WUDHU

|   |   |   |   |   |   |   |   |
|---|---|---|---|---|---|---|---|
| G | U | I | D | A | N | C | E |
| T | B | F | F | D | G | I | E |
| C | A | B | H | A | M | B | B |
| E | H | W | D | A | H | A | I |
| T | I | U | H | B | L | R | R |
| O | R | D | F | E | J | A | C |
| R | A | H | D | F | E | L | S |
| P | C | U | C | K | A | D | L |
| I | B | A | D | A | H | Z | M |
| P | R | O | P | H | E | T | S |

QUR'AN WORDS

# Qur'an Made Easy

Allah made it easy for the people to learn and understand the Qur'an.

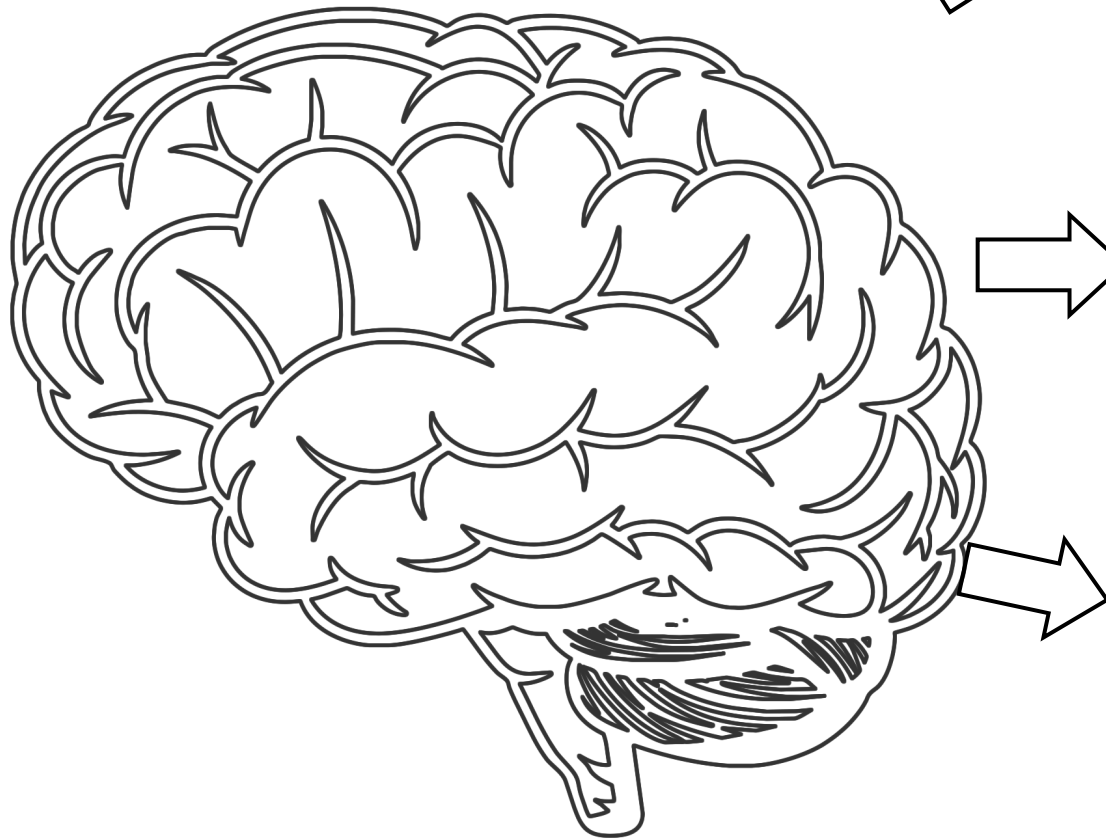

1

The Qur'an was revealed in Arabic which was a very rich and beautiful language. The Arabs understood and loved Arabic.

2

Allah tells us in the Qur'an that the Qur'an will be easy to memorise. Millions of Muslims have memorised it.

3

The Prophet Muhammad ﷺ explained the Qur'an to the people. He even taught some tribes how to recite it in their own dialects.

# The Suhuf

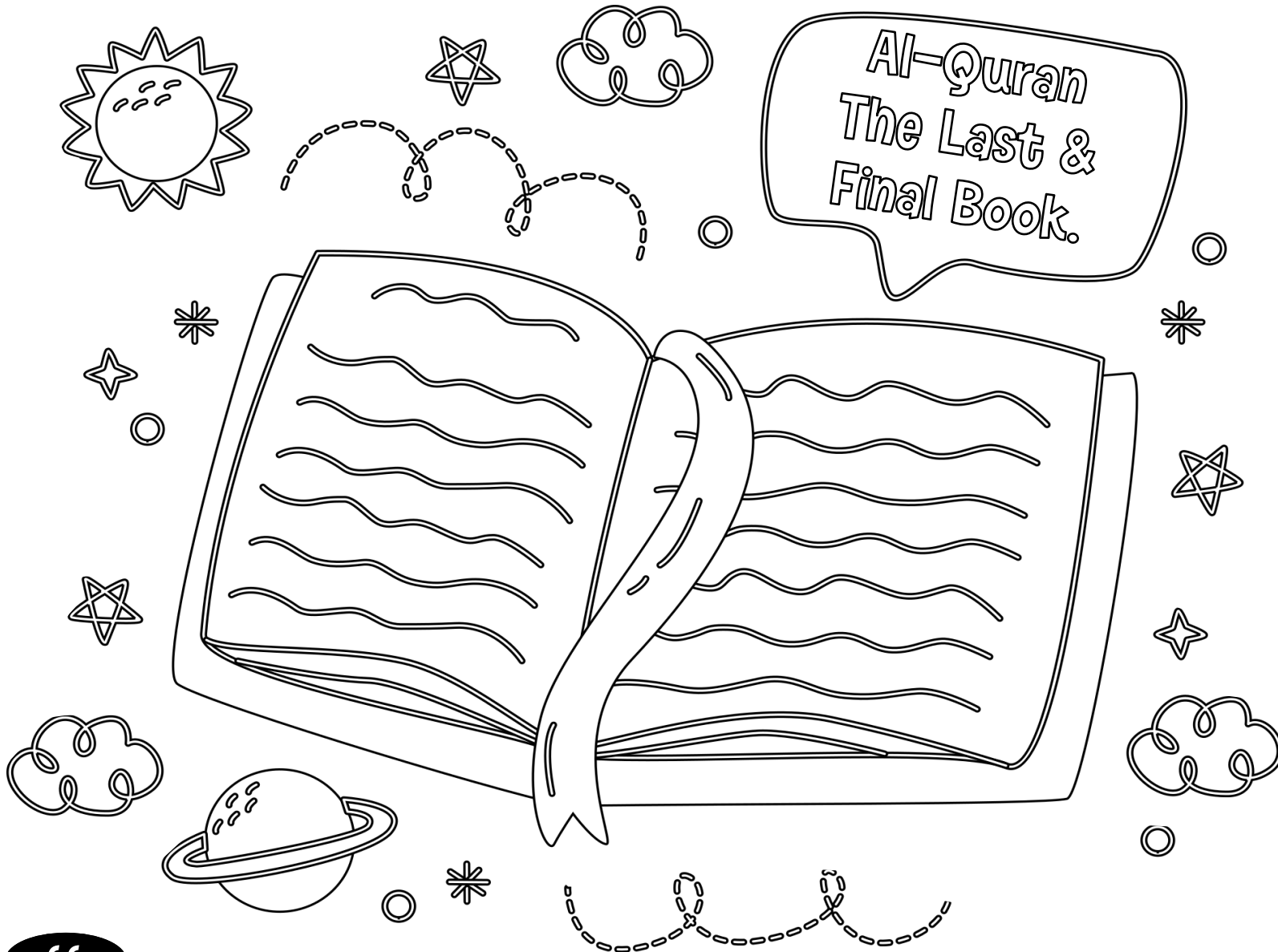

After Prophet Muhammad ﷺ passed away, the written verses were collected and put together in one collection.

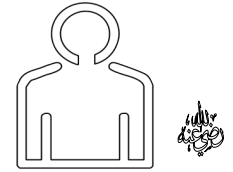

ZAYD BIN THABIT

was one of Prophet Muhammad's ﷺ main scribes. He was given the duty of collecting all the verses together.

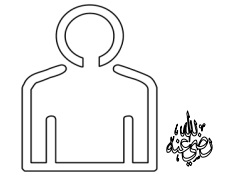

ABU BAKR

This was carried out at the time of Abu Bakr ﷺ the first Khalifah (Caliph).

# Spreading the Qur'an

The third Khalifah sent copies of the Qur'an and Huffaz to teach the people in far away Muslim lands.

Asked Zayd bin Tabit رضي الله عنه and other huffaz to collect Qur'an.

All the Sahabah رضي الله عنهم checked and agreed there were no mistakes.

They made copies of the Qur'an and sent them throughout the Muslim empire.

The Huffaz were sent with the copies to teach the people.

BOOKS



Uthman bin Affan رضي الله عنه was the third Khalifah (Caliph) of Islam.

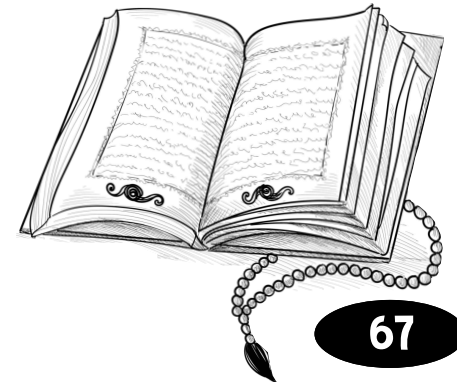

# Preserving it!

1

The scholars wrote down the **meanings** of the words and different phrases used in the Qur'an. They also wrote the rules of grammar.



2

The scholars wrote down the **explanation** of the Qur'an as the Prophet Muhammad ﷺ taught it and when the verses were revealed.



3

The scholars wrote down the rules of how to **pronounce** the Qur'an properly. This is known as Tajweed.



4

The scholars wrote the dots, i'rab (zabr, zeyr, pesh | Fatha, Dhamma, Kasra etc) so that people could **read** without knowing Arabic in depth.







**THE LAST BOOK**

**1**



**THE LAST PROPHET**



**2**

**BOOKS**

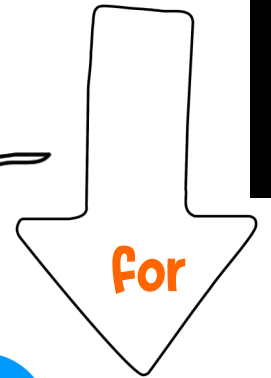

**3**

**THE LAST UMMAH**

**LAST LESSON**

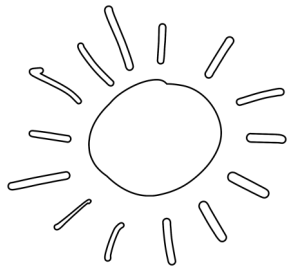

**4**

**THE LAST DAY**

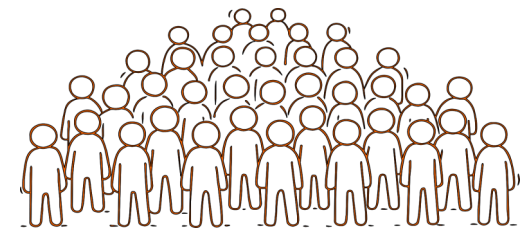
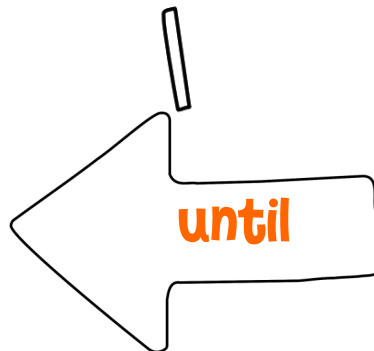

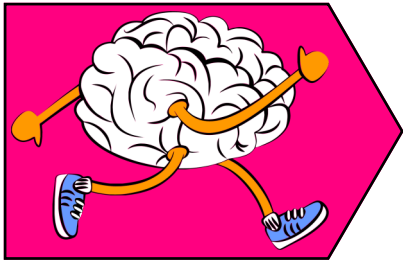

SUHUF

Meaning  
Pronounce  
Explanation  
Reading

ZAYD BIN THABIT

Scribes

WORDFIT

Arabic  
Books  
Heart  
Huffaz

Injeel  
Last  
Message  
Protected

Qur'an  
Scribe  
Tawrah  
Zaboor

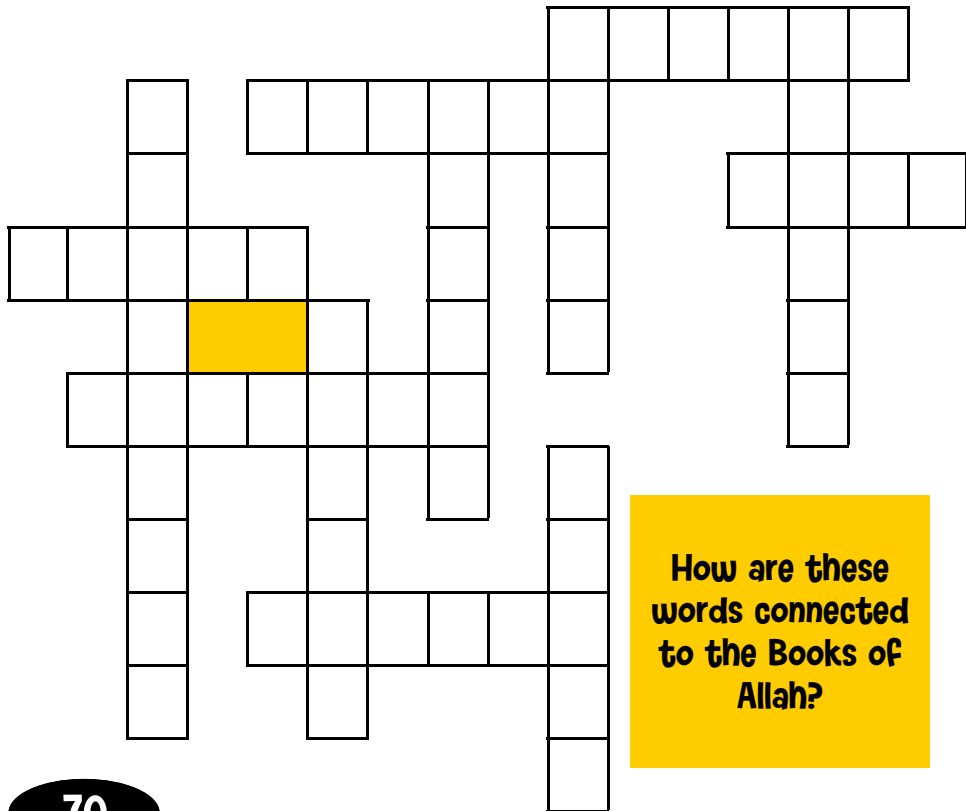

How are these words connected to the Books of Allah?



FIVE LESSON

- ⦿ Five adaab of the Qur'an.
- ⦿ Five names of the Qur'an.
- ⦿ Five ways the Qur'an is different from other books.
- ⦿ Five ways the Qur'an and its message was preserved.
- ⦿ Facts about five Suwar
- ⦿ Five prophets that were given books or scrolls.

ABU BAKR

HADRAT UMAR

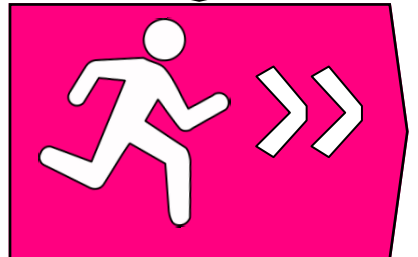

HADRAT UTHMAN

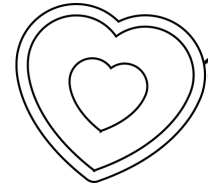
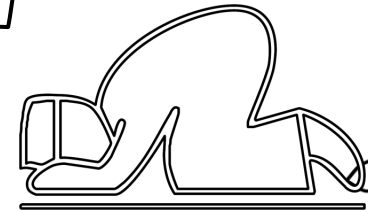

# Prophets

of Allah





Allah sent

approx

124,000

Prophets

According to Hadith,  
about 124 thousand  
prophets were sent.



# Every Nation was sent a prophet



PROPHETS

Each nation or group of people received at least one prophet, and in some instances, they were blessed with multiple prophets.

# Prophets

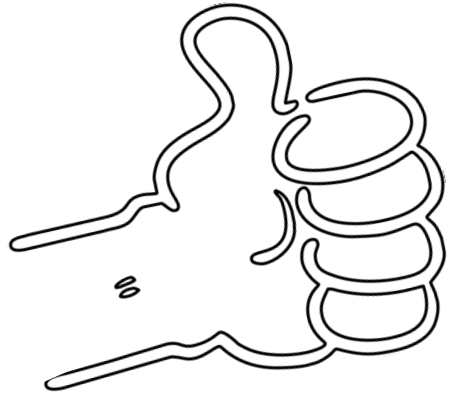

only did

What different kinds  
of good things  
did they do?

good

Prophets were an  
excellent role model  
for their people to  
follow.



things



Allah would choose  
the BEST  
person

to be a prophet

PROPHETS

The best  
people ever were  
the prophets of  
Allah.

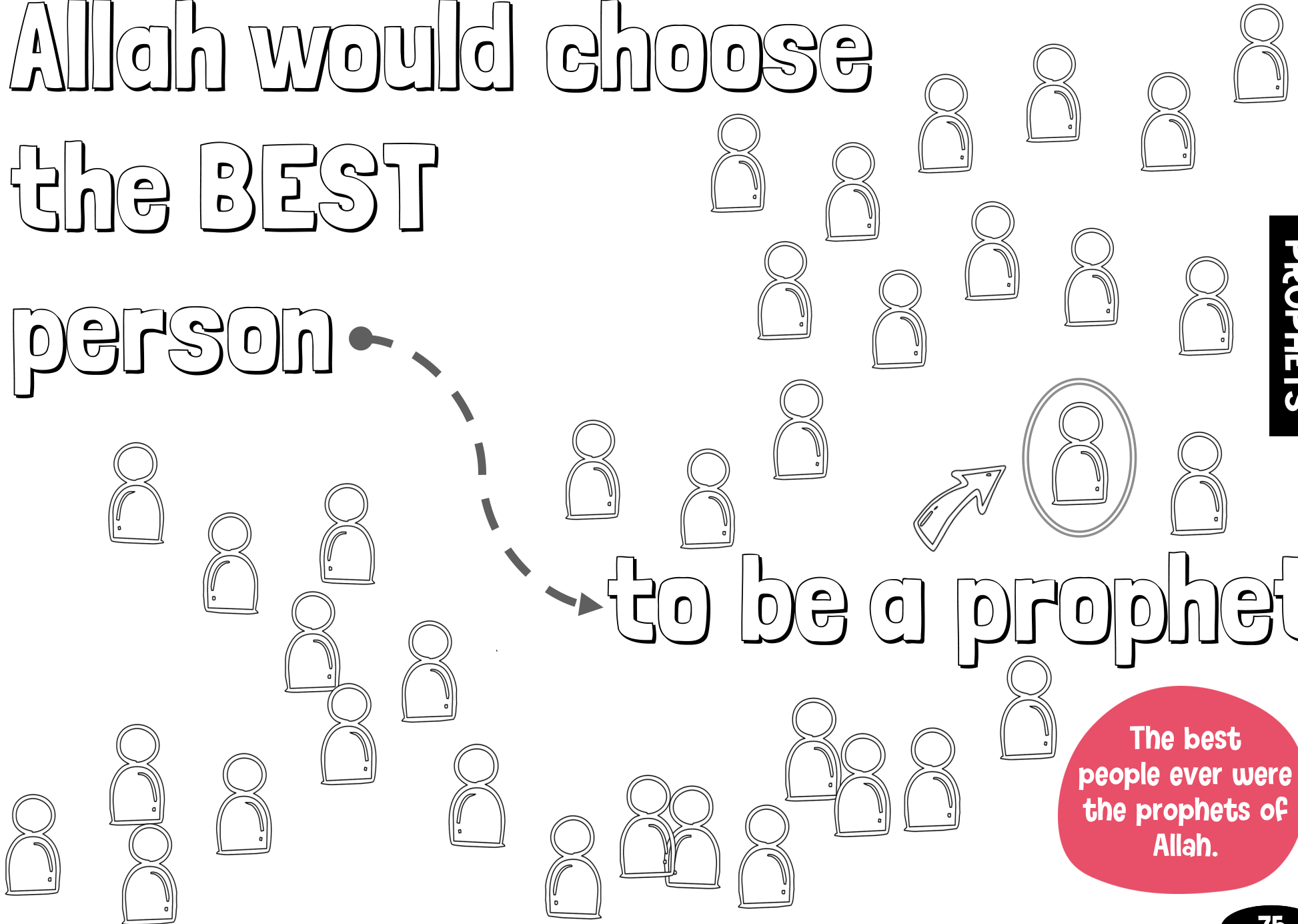

# Prophets

are like SPECIAL  
TEACHERS

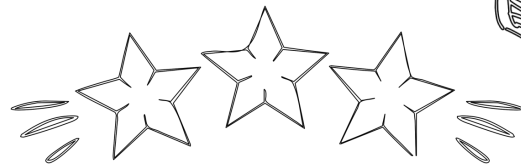



# Prophets taught ...

**Allah is One**  
Worship only Allah

**Be Good**  
Only do good deeds

**Don't be Bad**  
And stay away from  
bad things

**Accountability**  
Allah will ask us  
about what we did

PROPHETS

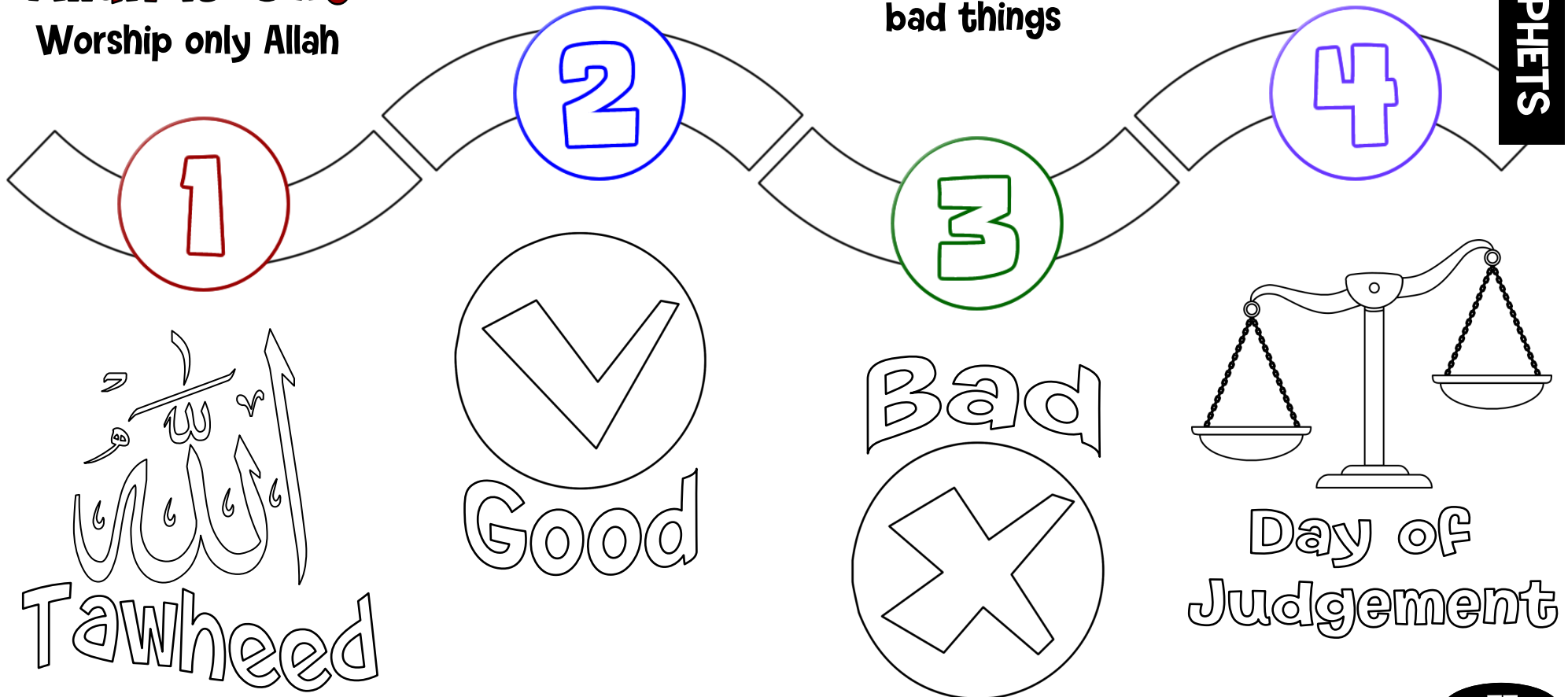

# CROSSWORD

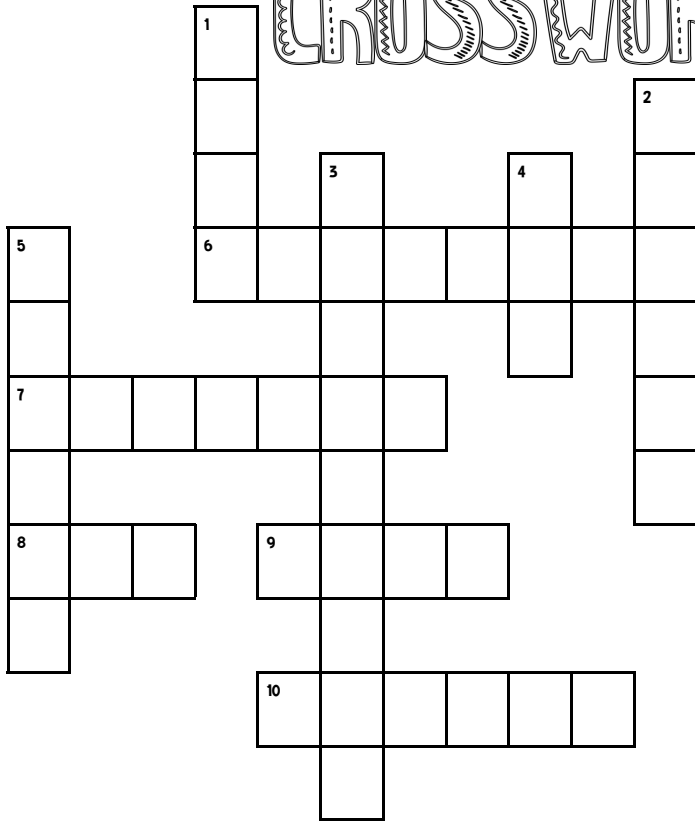

- ↓**
- The \_\_\_\_ people were the prophets.
  - We know from \_\_\_\_\_ how many prophets were sent.
  - The prophets were good r\_\_\_\_\_ for their people.
  - Prophets told the people to stay away from \_\_\_\_\_.
  - Every \_\_\_\_\_ was sent a prophet.

- 
- 124\_\_\_\_\_ were sent by Allah.
  - All prophets taught \_\_\_\_\_.
  - All prophets taught that Allah is \_\_\_\_\_.
  - Prophet were all \_\_\_\_\_ people.
  - The best \_\_\_\_\_ were the prophets.

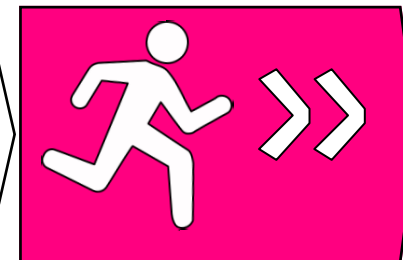
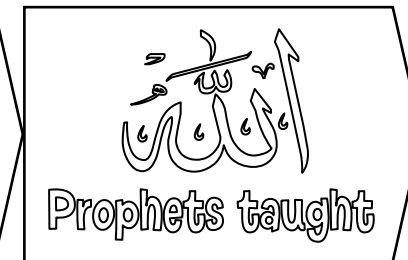
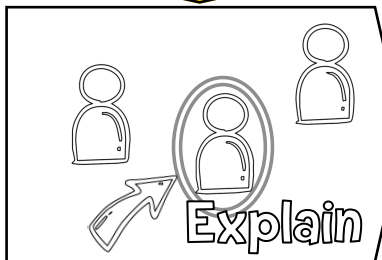
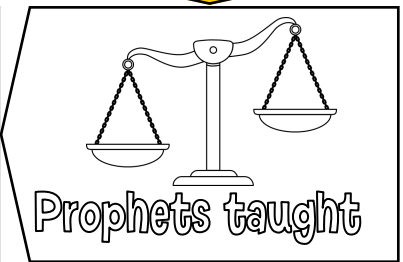
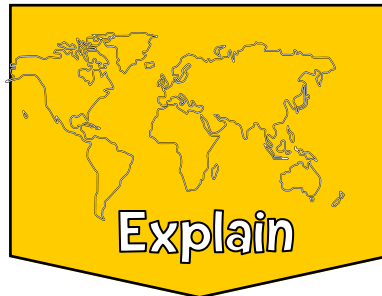
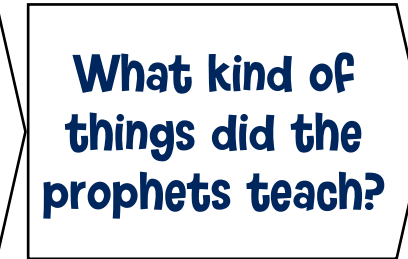
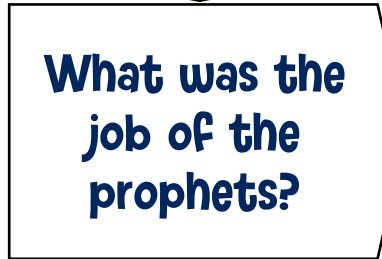
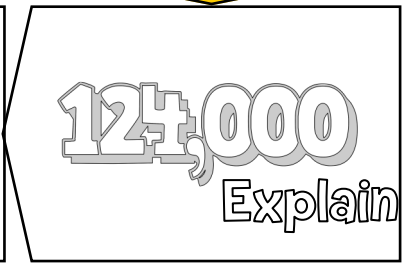
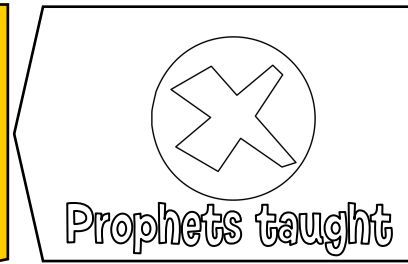
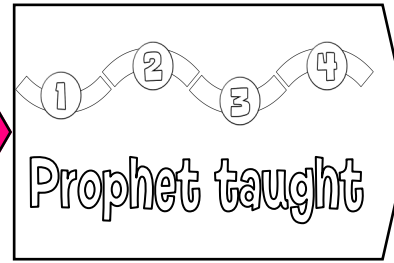
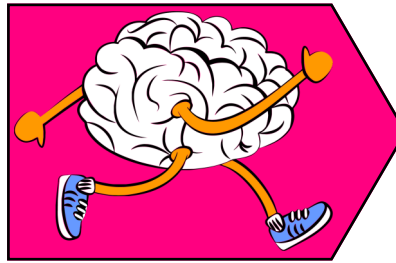

We say

صلى الله  
عليه  
وسلم

**Sallallahu  
alayhi  
Wasallam**

whenever we read,  
hear or say our  
Prophet's name.

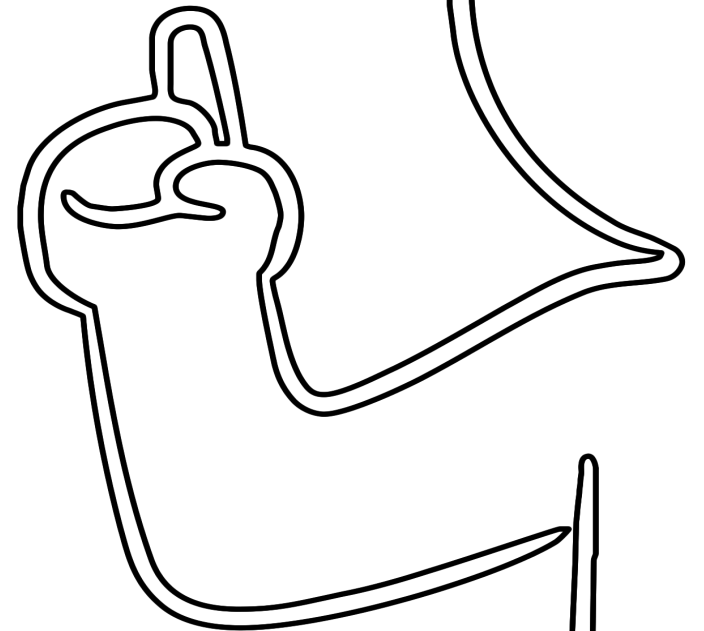
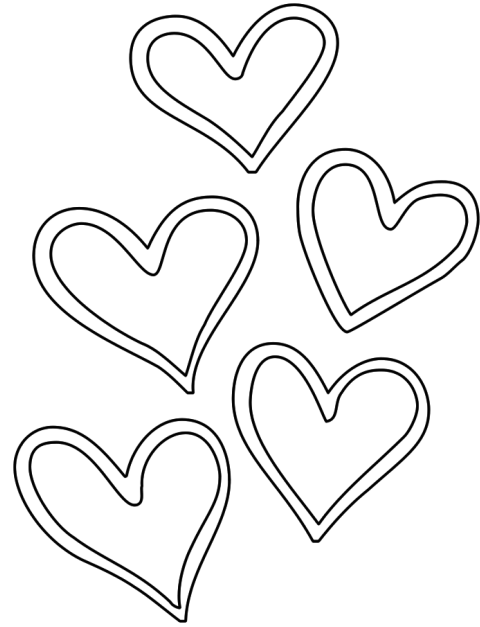

When we mention the  
name of a different  
prophet  
we say

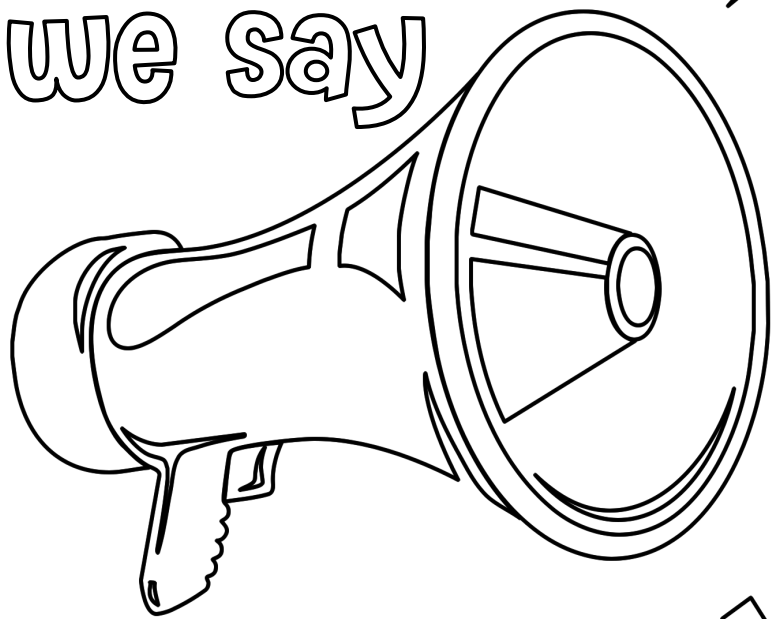

Peace be upon him

عليه السلام

Alayhis Salaam

# Prophets mentioned in the Qur'an



**Adam, Nuh, Idris, Hud, Salih,**  
**Ibrahim, Lut, Ismail,**  
**Al-Yasa, Zulkifl, Ilyas,**  
**Ayyub, Yunus, Ishaq,**  
**Yaqub, Yusuf, Shuaib,**  
**Musa, Harun, Dawud,**  
**Sulaiman, Zakariya,**  
**Yahya, Isa and**  
**Muhammad.**

(Peace be upon them all)

25

PROPHETS

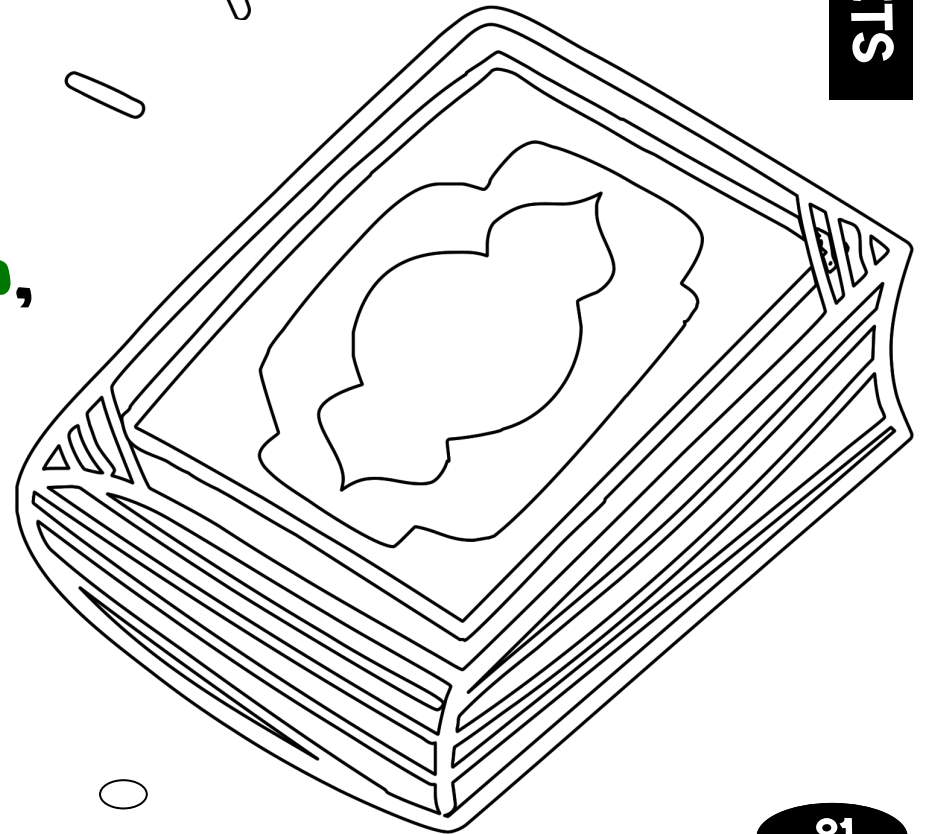



# First Prophet

# ADAM

آدم

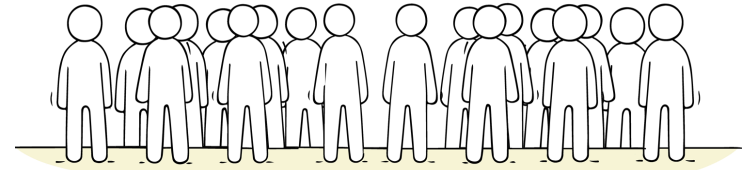

Allah sent many prophets

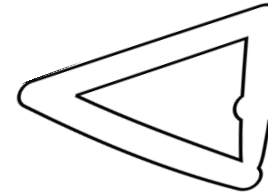

# Last Prophet

# MUHAMMAD



محمد



Every prophet taught tawheed

# Many prophets were given miracles



So that people would know they were true prophets from Allah.

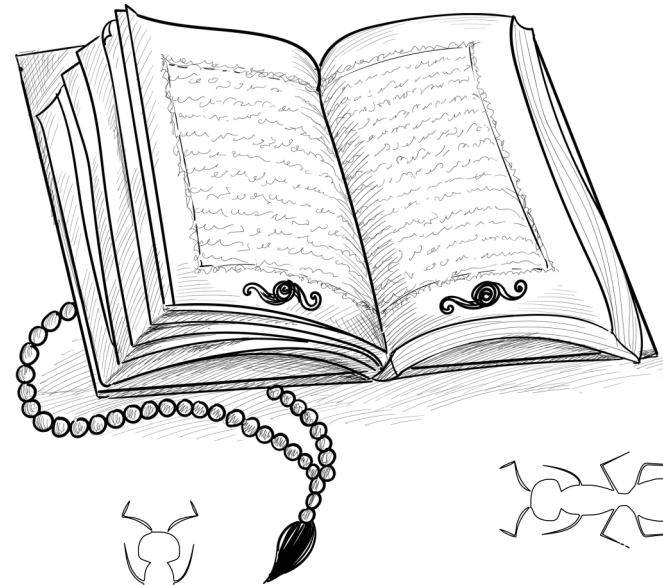

WOW!

Musa عليه السلام – Isa عليه السلام – Sulaiman عليه السلام – Muhammad صلى الله عليه وسلم

PROPHETS

A Rasool was given a new message from Allah. The people would follow the new commands that the prophet gave them.

# Rasool & Nabi

A Nabi taught the same message that the previous prophet had given the people. A Nabi revived the existing message.

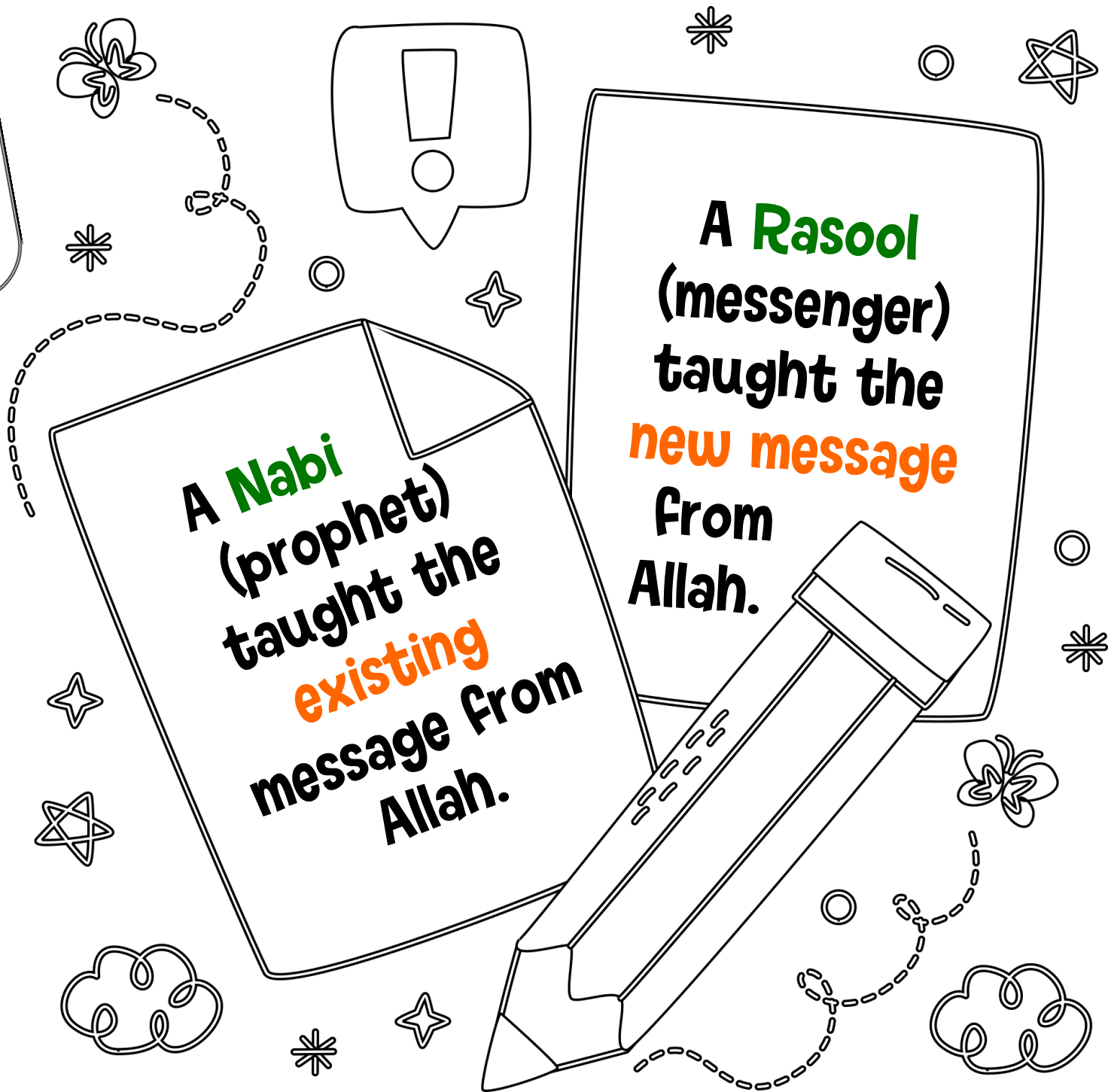



After Prophet Muhammad ﷺ made the Hijra to Madina. Masjid Nabawi was established so Muslims could pray together.

Help Abdullah get to the Masjid and catch up with his Qur'an.

Amazed 



This is Masjid Nabawi, the Prophet's Masjid in Madina.

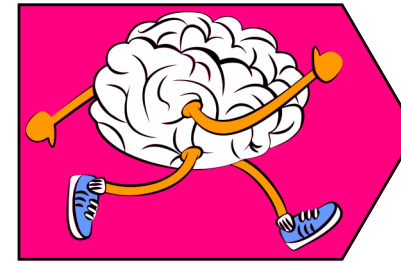
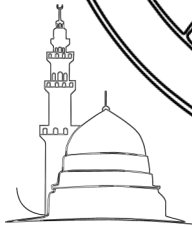

Tell me the miracles of some prophets

الأنبياء  
Explain

PROPHETS

Nabi Rasool

رسول الله  
Explain

Name five Prophets

Why were some prophets given miracles?

Unscramble the prophets' names.

|   |   |   |   |   |   |   |   |   |
|---|---|---|---|---|---|---|---|---|
| A | M | A | U | M | M | H | D | = |
| A | B | I | R | I | M | H |   | = |
|   |   | A | B | U | Y | Y |   | = |
|   |   |   | U | N | H |   |   | = |
|   |   |   | A | I | S |   |   | = |
|   | U | Y | S | F | U |   |   | = |
|   |   | A | S | U | M |   |   | = |
|   | U | U | Y | N | S |   |   | = |

25  
Explain



# Prophet Muhammad

صَلَّى اللهُ عَلَيْهِ وَسَلَّمَ

was  
given  
the  
Qur'an



Prophet

Muhammad

had the best character



PROPHETS



Honest



Fair



Generous



Helpful

We should try and be like Him

# Prophet MUHAMMAD

is the Last and Final messenger of Allah

No more prophets or messengers will come after him!

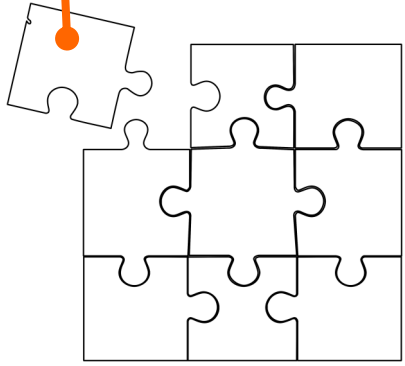

Can you explain this picture?

Final brick missing

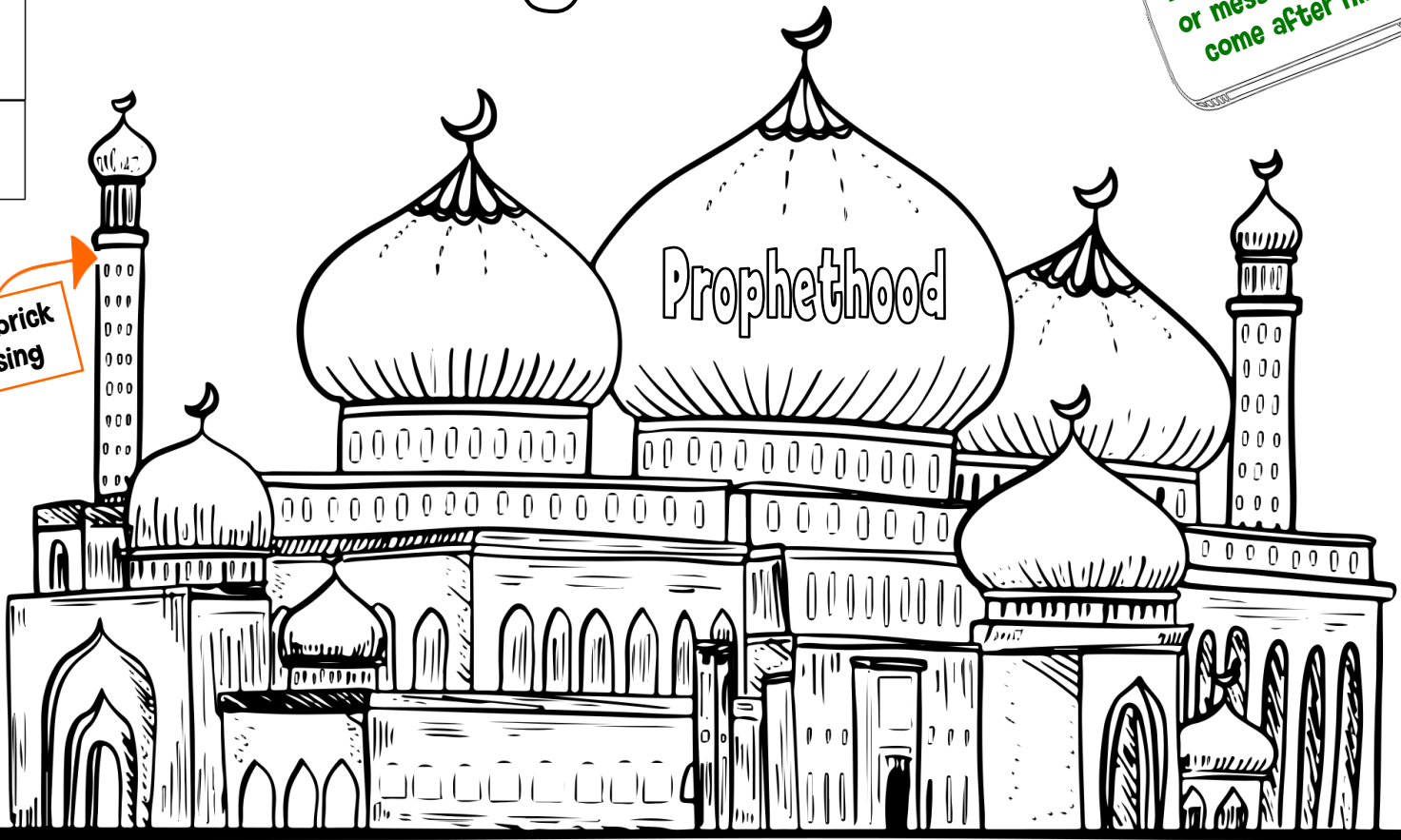

Prophet

# Muhammad



PROPHETS

**always** spoke the truth

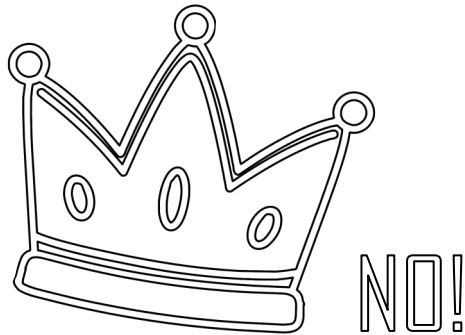

The people of Makkah offered him to be their leader if he stopped teaching Islam.

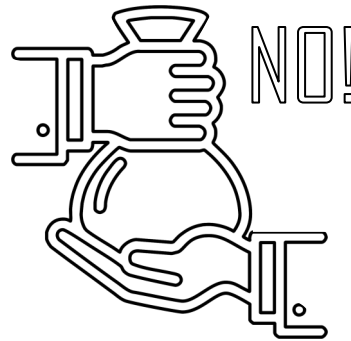

The people of Makkah offered to make him the richest person if he stopped teaching Islam.

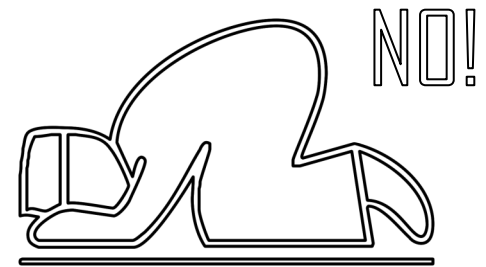

The people of Makkah offered to have turns at worshipping Allah and the Idols!

TRUTH IS ALWAYS MORE IMPORTANT

# Prophet Muhammad left us

صَلَّى اللَّهُ عَلَيْهِ وَسَلَّمَ

# the Qur'an and Sunnah

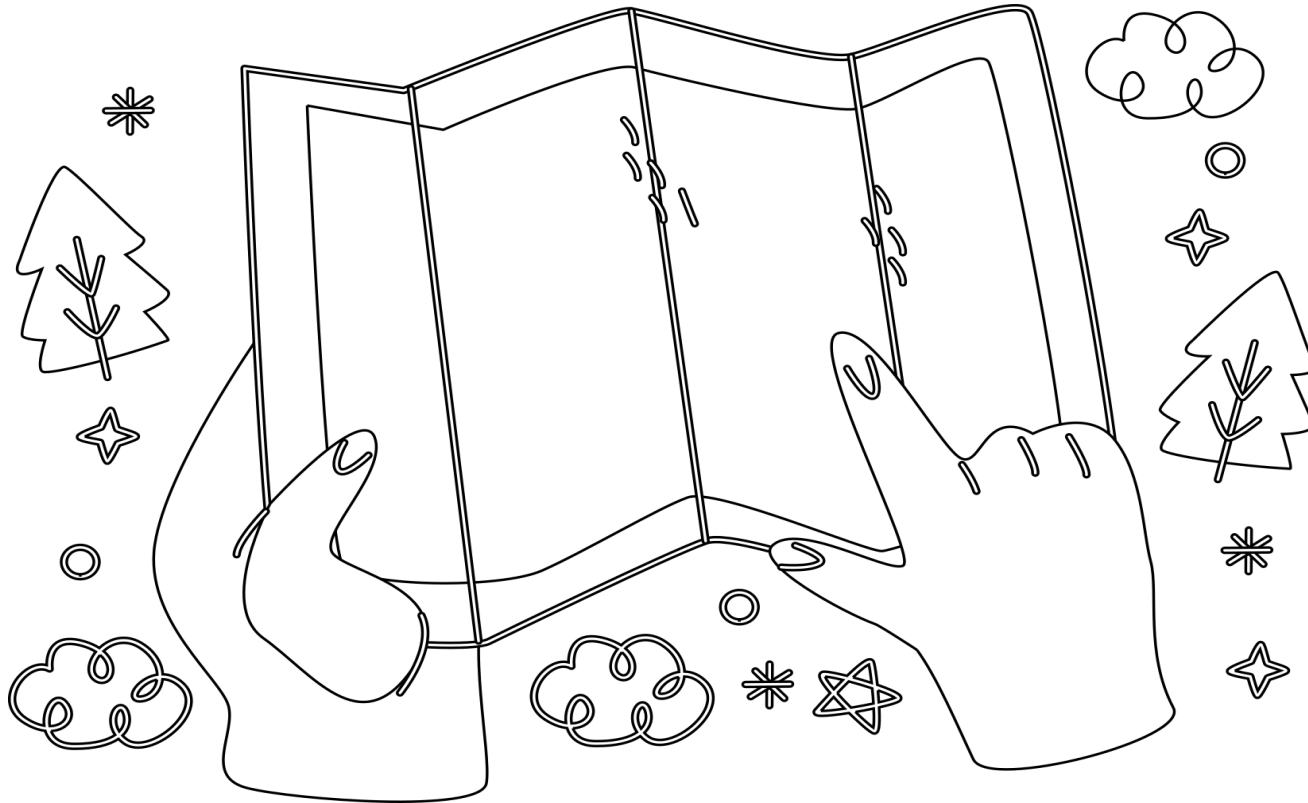

SEARCH

FINAL GUIDE  
HONEST  
LAST MANKIND  
MIRACLE  
NABI  
QUR'AN  
RASOOL  
SUNNAH  
TRUTHFUL  
WUDHU

|   |   |   |   |   |   |   |   |
|---|---|---|---|---|---|---|---|
| H | O | N | E | S | T | Q | L |
| B | L | D | A | E | J | U | K |
| C | X | O | D | B | F | R | T |
| Q | C | I | O | H | I | A | E |
| B | U | S | T | S | N | N | L |
| G | Q | U | S | J | A | K | C |
| F | R | N | A | H | L | R | A |
| T | Q | N | L | P | M | L | R |
| R | G | A | X | N | H | T | I |
| F | U | H | D | U | W | L | M |

PROPHET KEYWORDS

# to guide us in Life

# Prophet

# MUHAMMAD

صلى الله  
عليه  
وسلم

## Came for all mankind

PROPHETS

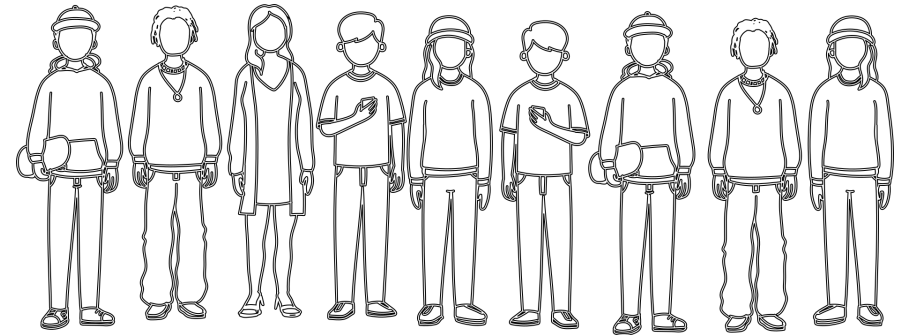

Other prophets came  
to their own people

# Fake Prophets



There are many people that claim to be prophets after Prophet Muhammad ﷺ. These people have all been fake prophets.

We must be careful to avoid all these false prophets because they will always lead towards Jahannam.

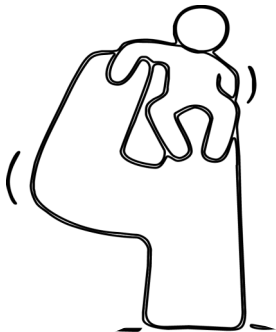

We must never fall into the trap of Shaytan by thinking Allah would send another prophet after Prophet Muhammad ﷺ.

Prophet Isa عليه السلام will come back to fight the Dajjal near the Last Day. He will come as a follower of Prophet Muhammad ﷺ.

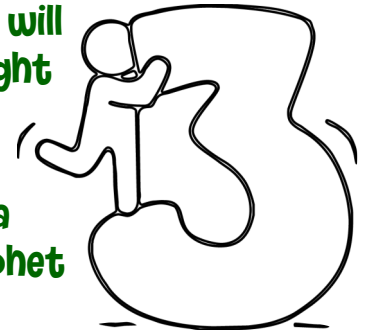



Which prophet does each of these pictures represent ?

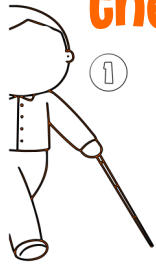

1



3



4

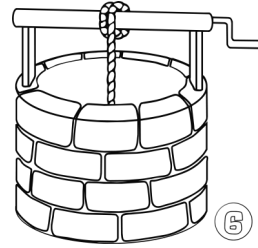

6

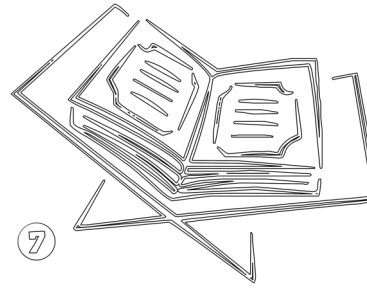

7

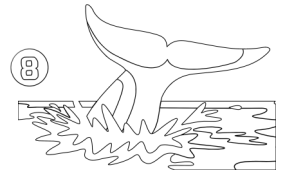

8

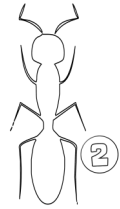

2

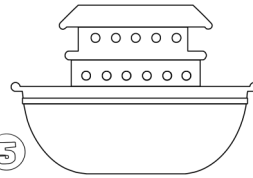

5

Muhammad ﷺ is the last and final messenger of Allah.

His message is for everyone until the Day of Judgement.

He left us the Qur'an & Sunnah to follow.

PROPHETS



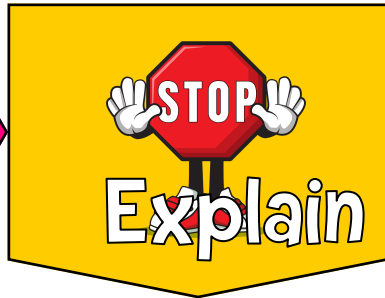
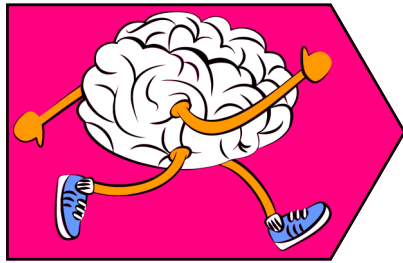

# << WordSearch >>

|   |   |   |   |   |   |   |   |   |   |   |   |   |   |
|---|---|---|---|---|---|---|---|---|---|---|---|---|---|
| A | L | L | A | H | J | M | P | Q | T | E | A | C | H |
| B | R | F | M | Q | Q | K | R | D | Q | C | P | C | M |
| H | F | C | H | P | U | T | O | P | F | I | N | A | L |
| D | J | H | P | B | R | B | P | N | H | F | M | R | L |
| R | L | O | D | L | A | N | H | C | F | K | G | I | K |
| M | E | S | S | E | N | G | E | R | S | K | I | N | D |
| G | P | E | J | C | T | N | T | J | G | S | B | G | H |
| P | J | N | C | M | F | G | S | B | O | O | K | S | S |
| G | O | O | D | N | M | U | H | A | M | M | A | D | B |

# Amazed

Abdullah's Friends keep telling him that there was a new prophet after our Prophet Muhammad ﷺ.



Help Abdullah find new friends.

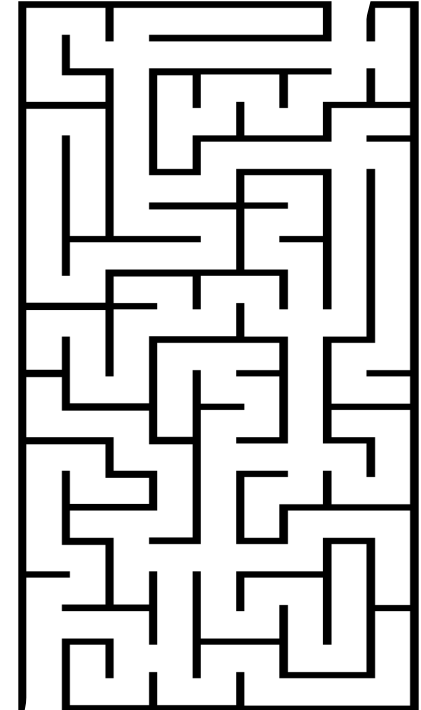

Who did Prophet Muhammad ﷺ come for?

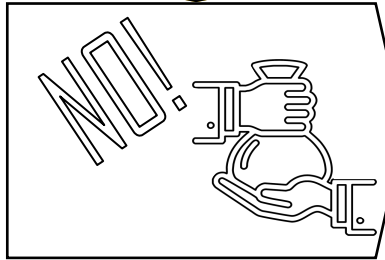

How should we try and be like Prophet Muhammad ﷺ?

How can we be guided in life?

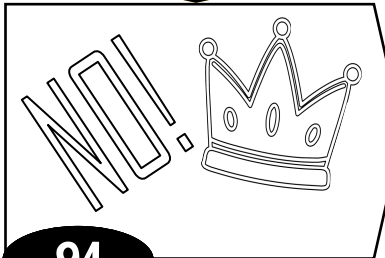

Difference between Prophet Muhammad ﷺ and other prophets



- ALLAH
- MUHAMMAD
- QUR'AN
- PROPHET
- FINAL
- CHOSEN
- CARING
- MESSENGER
- TEACH
- KIND
- BOOKS
- GOOD

Allah created everything with a purpose, and everything runs in harmony. What is our purpose?

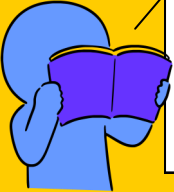
Our purpose is to live our lives according to Allah's command. We have free will, so we do this out of choice.

Friends take you towards Jannah or Jahannam. Where are your friends taking you? 

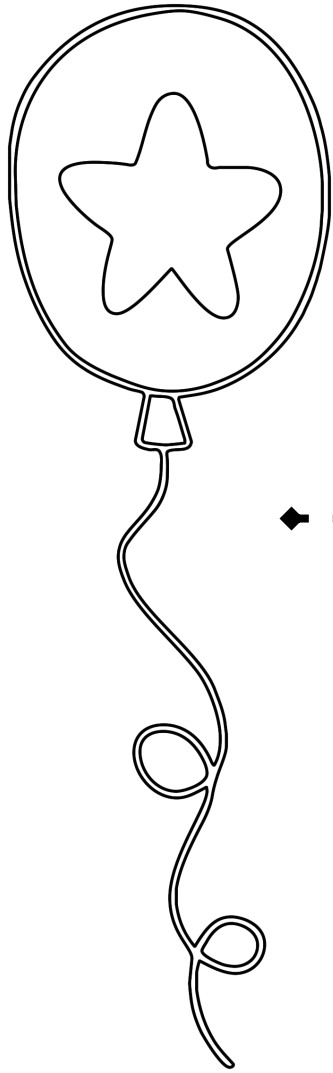

# Certificate of Completion

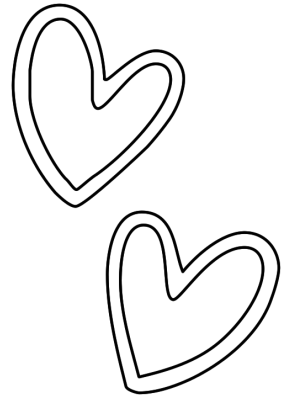

Name:



Ma-Sha-Allah well done for completing this book.  
You worked so hard to learn it and make it look beautiful.

You are  
Amazing!

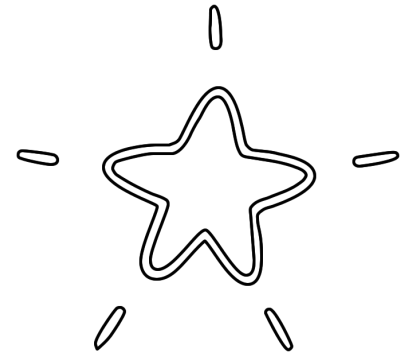

teacher



teacher



**The quality of a building is  
determined by the  
strength of its  
foundations. This book  
offers fundamental yet  
essential lessons to assist  
young individuals in  
establishing their  
foundational beliefs.**

ISBN 978-1-91-368615-4



[MusallaKidz.org](http://MusallaKidz.org)

**Musalla Kidz**

